

Rodzaje Krawędzi

A

zaokrąglenie

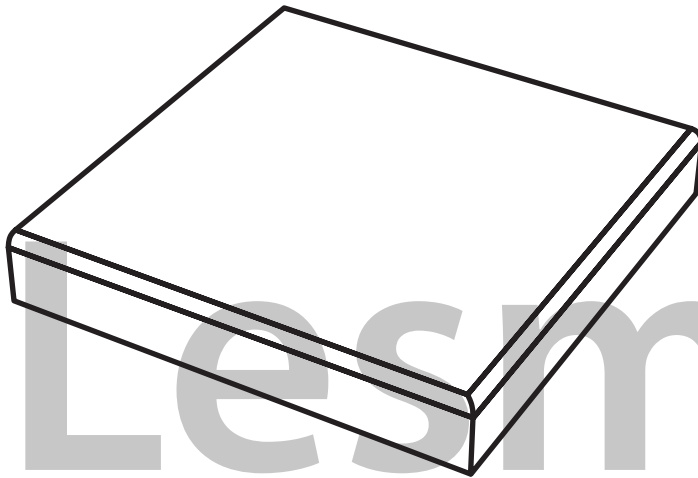
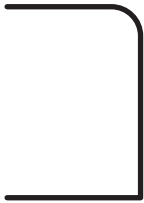

B

Faza 45 stopni

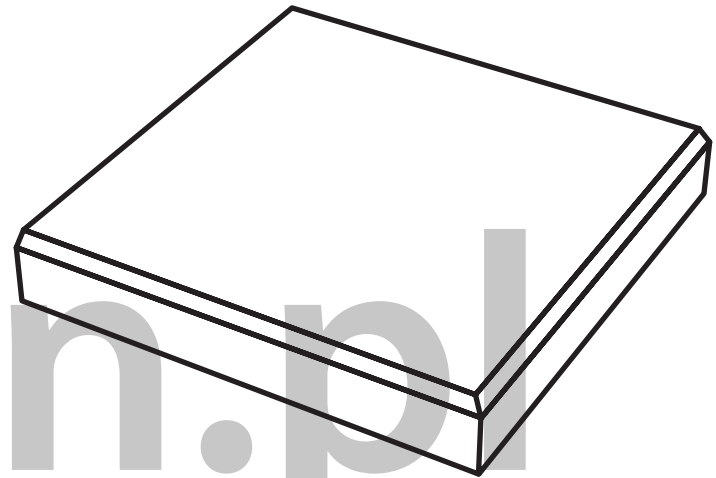

C

Faza 45 stopni +

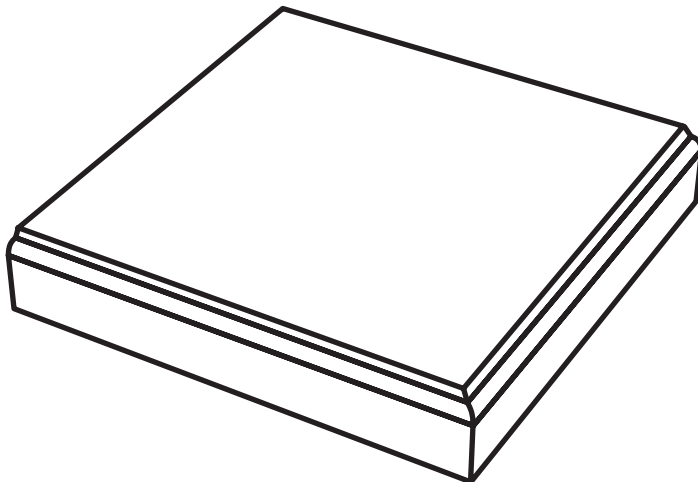
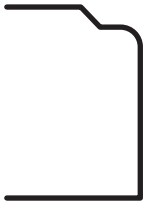

D

2xFaza 45 stopni

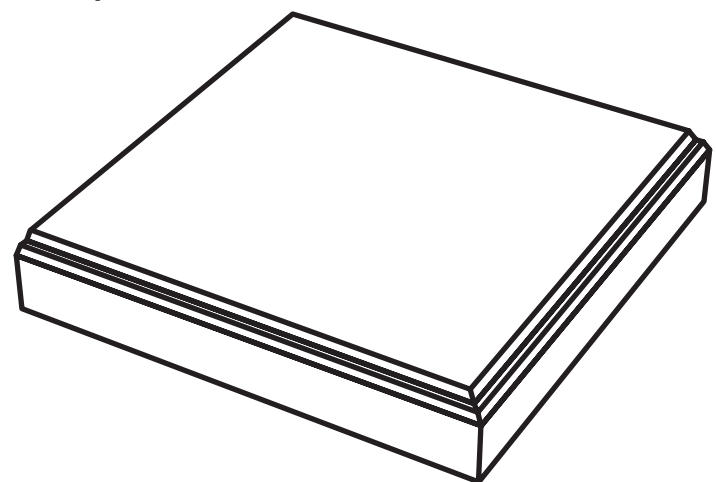
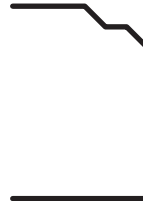

SE

Szpros Ekstra



SE1



SE2

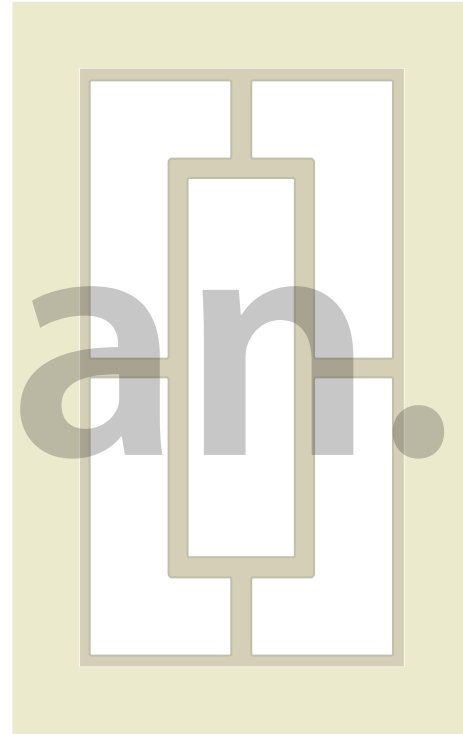

SE3

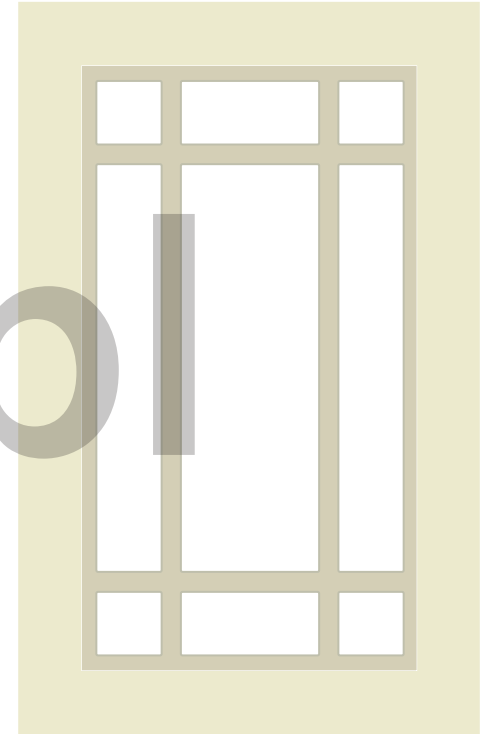

SE4

Lesman.pl

SW

Szpros Wysoki

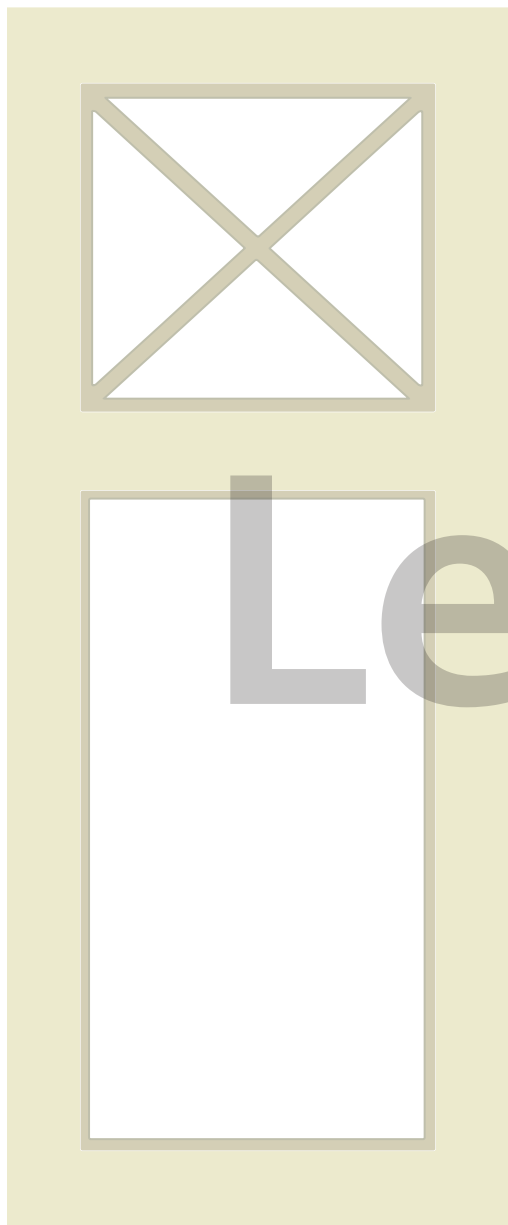

SW1

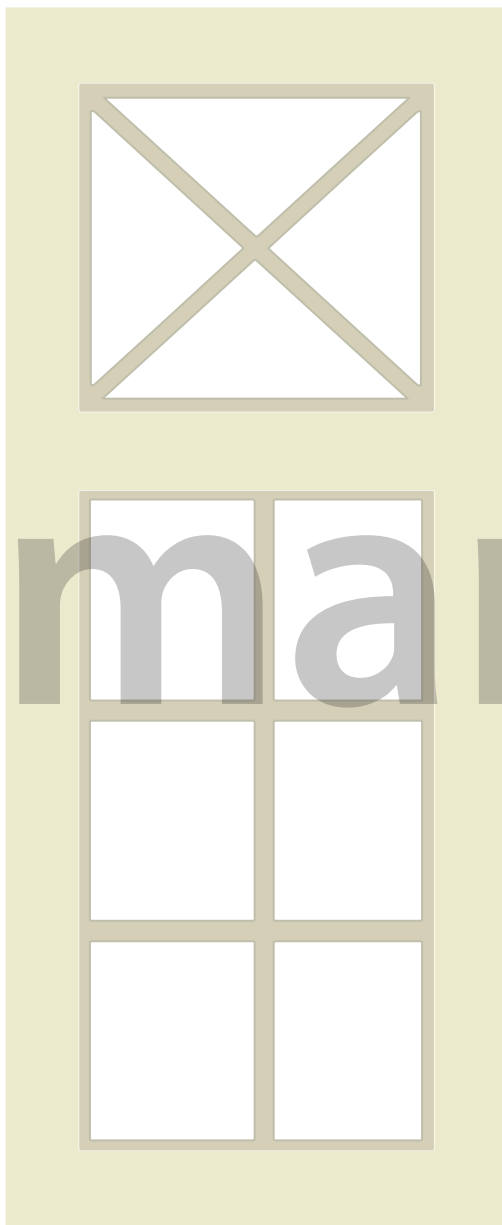

SW2

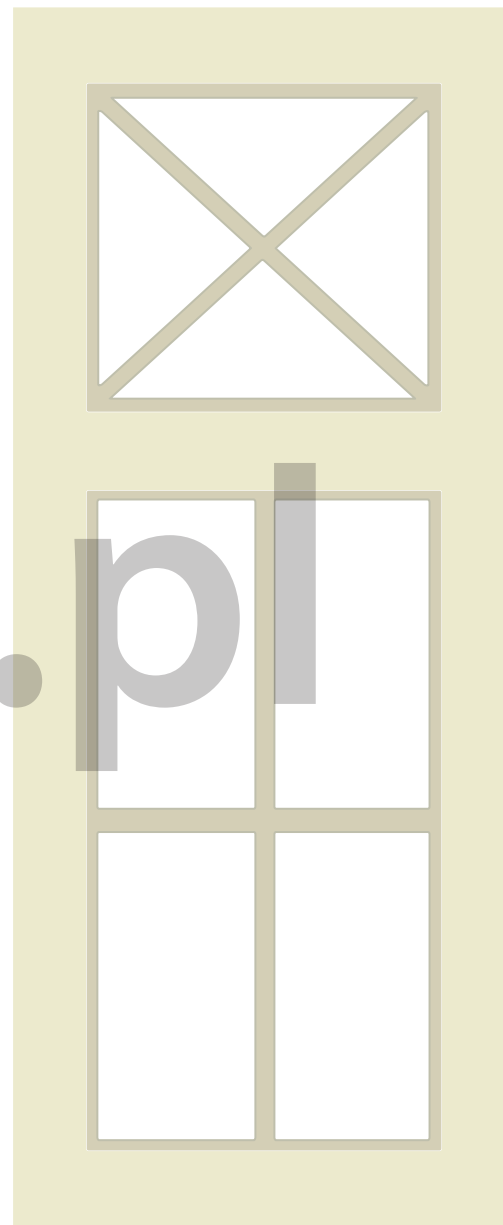

SW3

Lesman.pl

SW
SZPROS WYSOKI

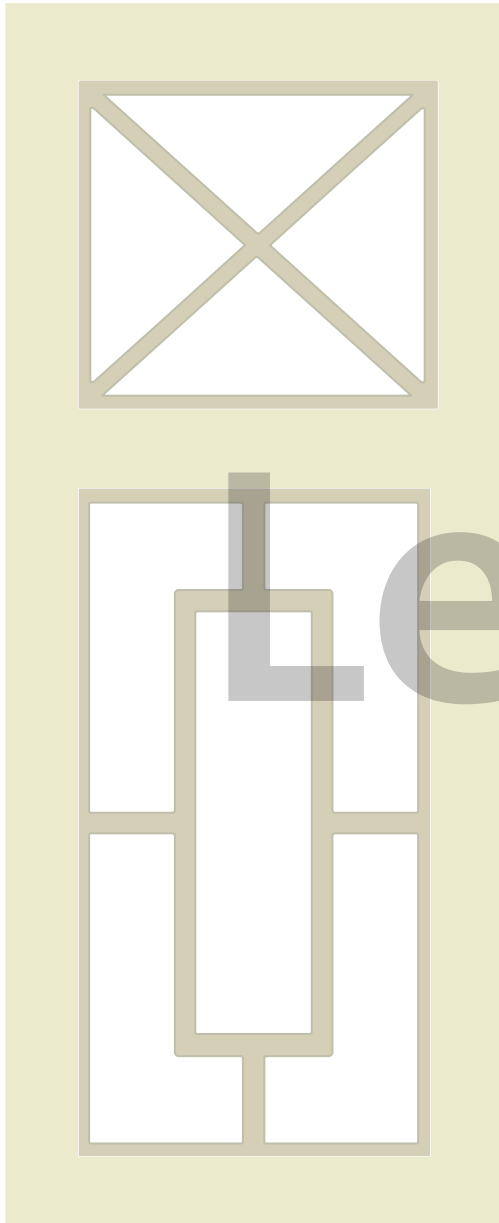

SW4



SW5

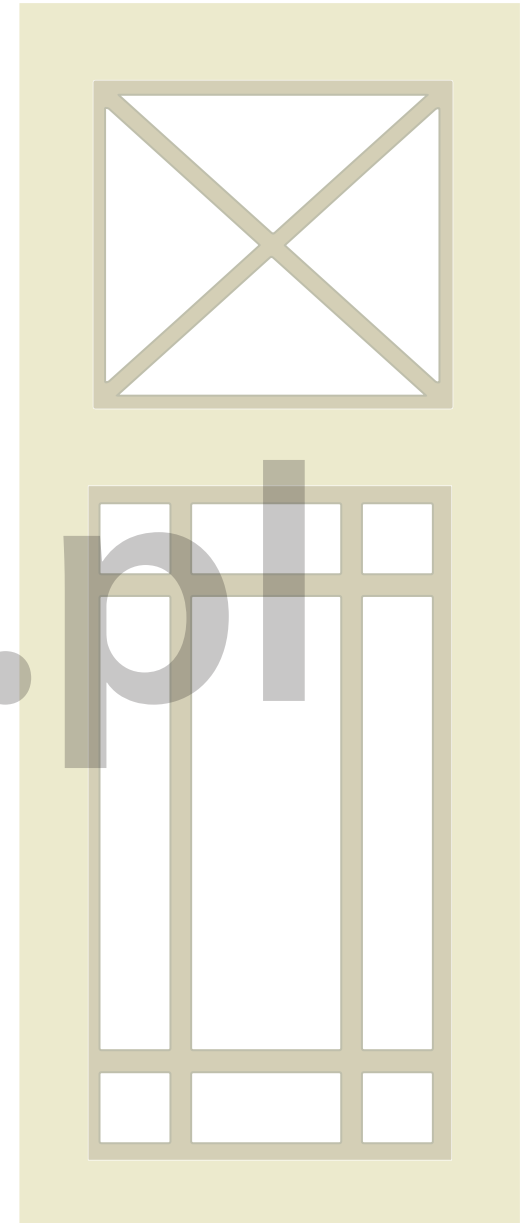

SW6

P1
Paski 1

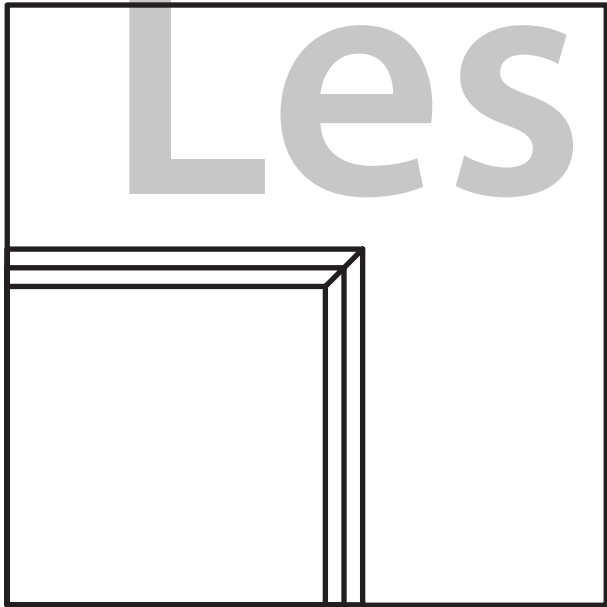
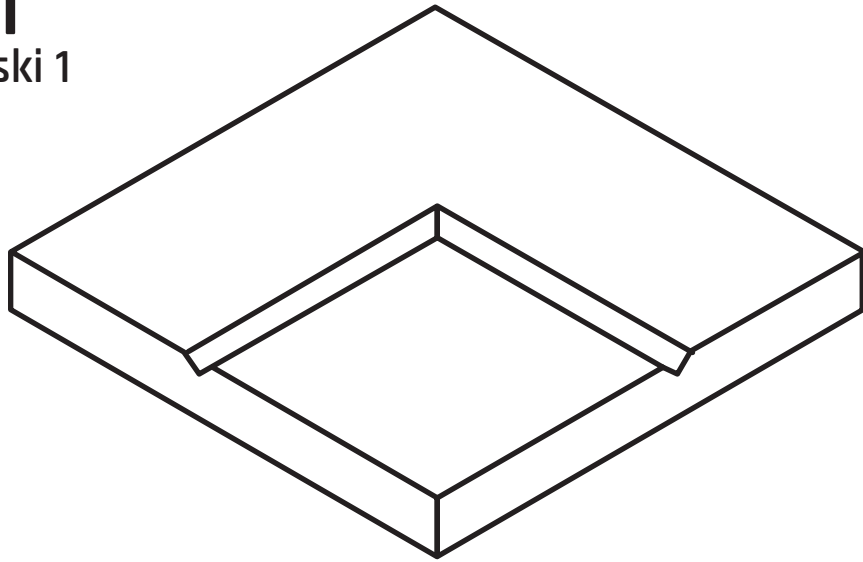

65



Front

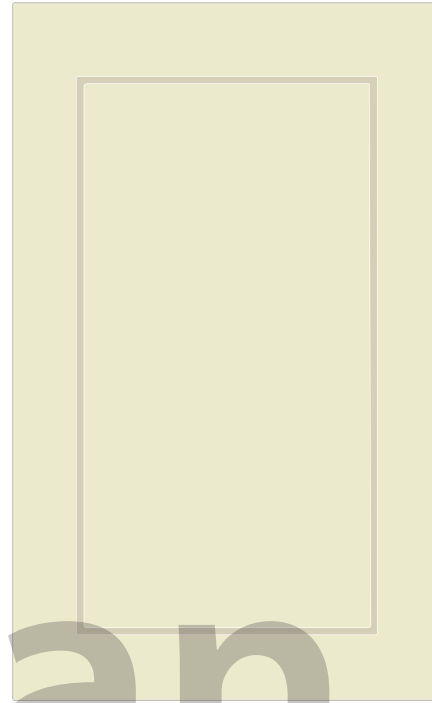

Witryna Szpros

Szuflady

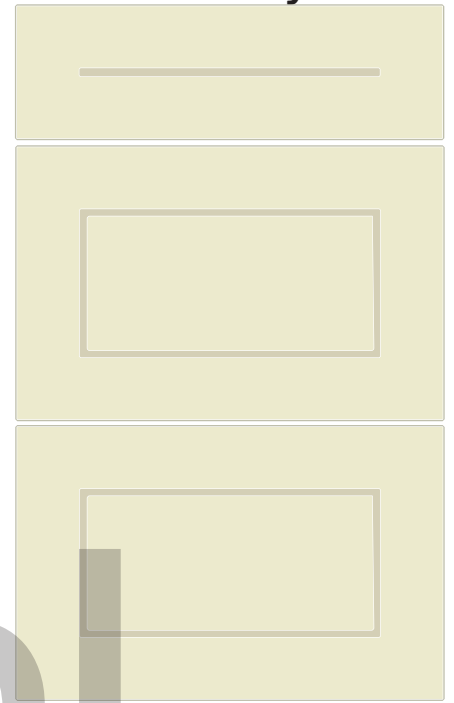

Witryna

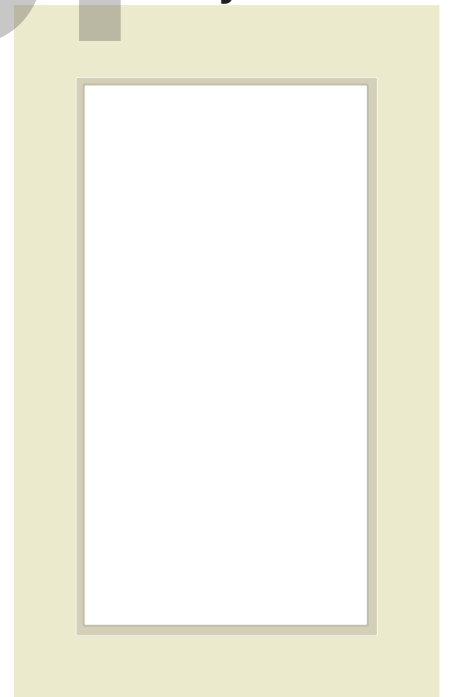
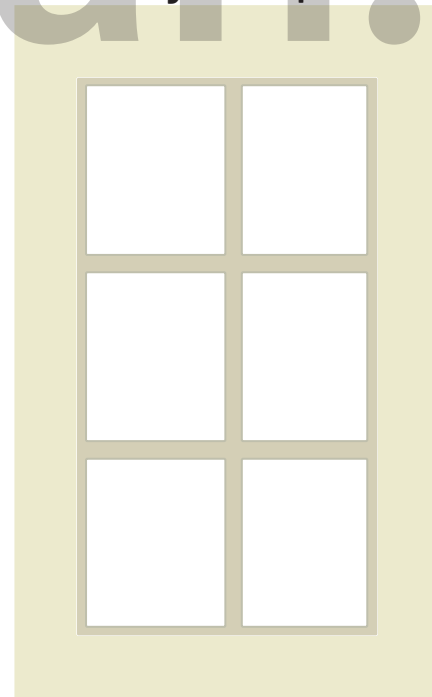

P3
Paski 3

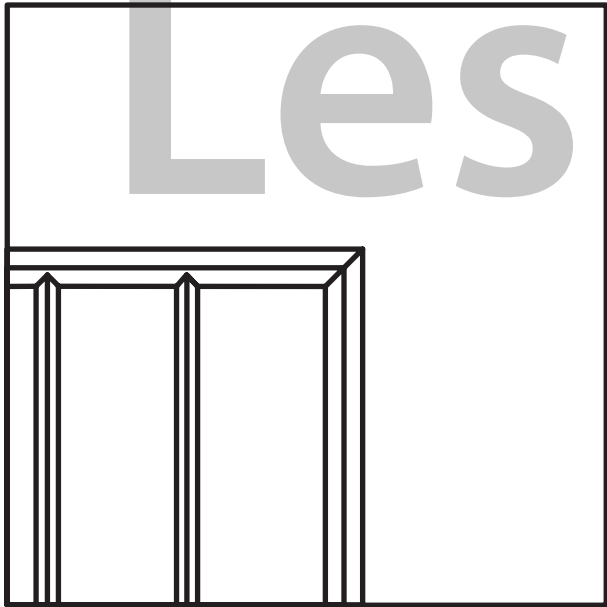
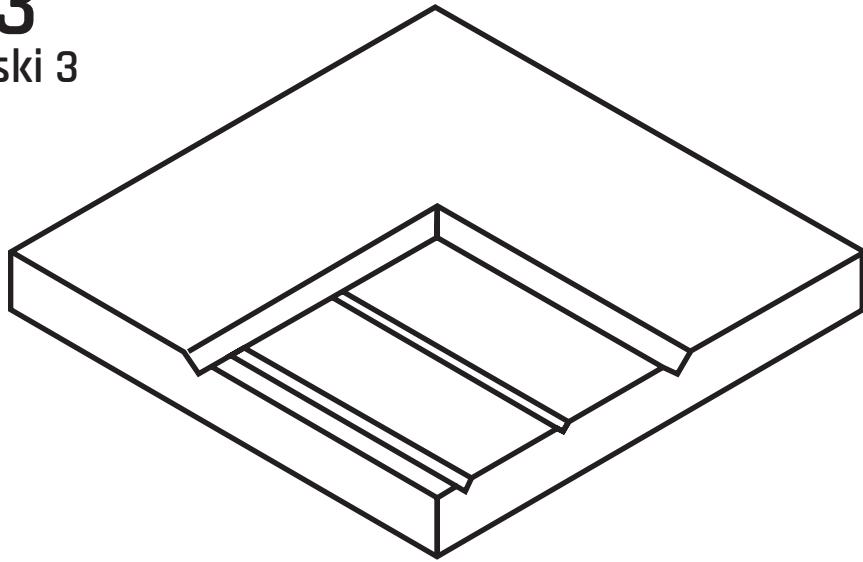

65



19

Front

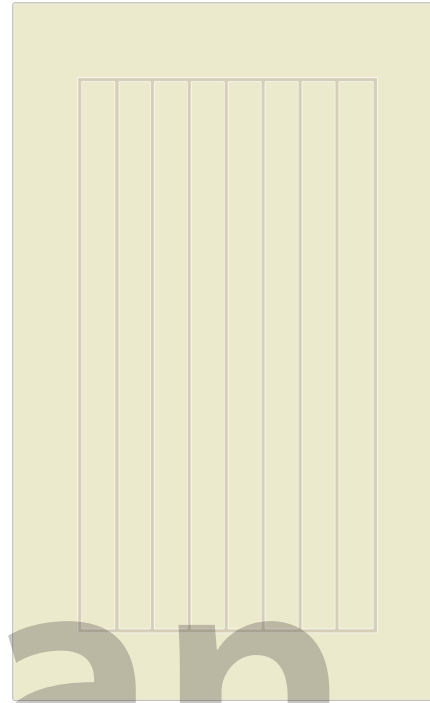

Witryna Szpros

Szuflady

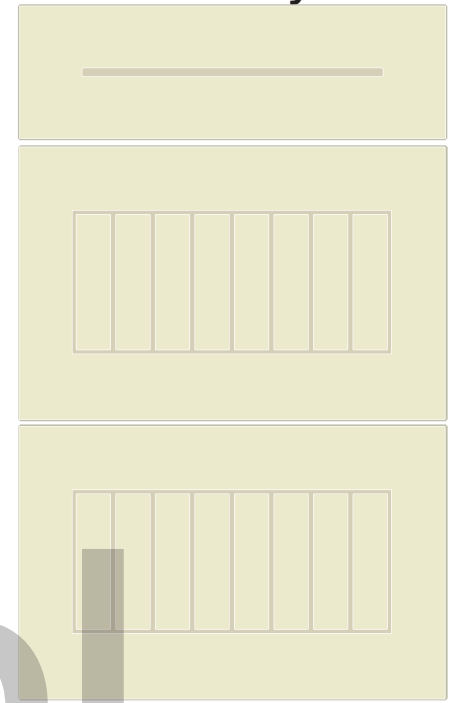

Witryna

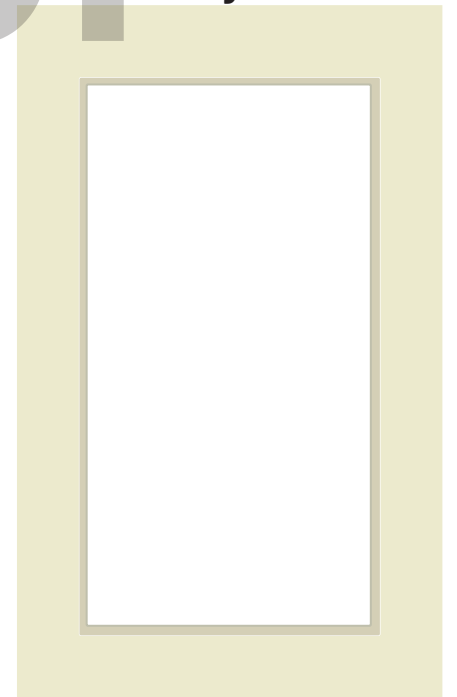
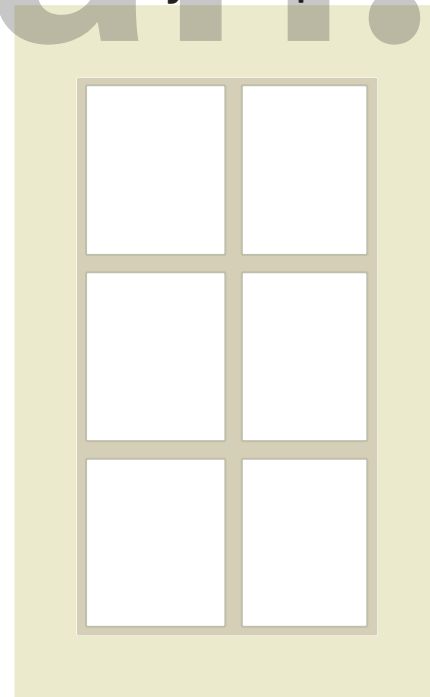

P2
Paski 2

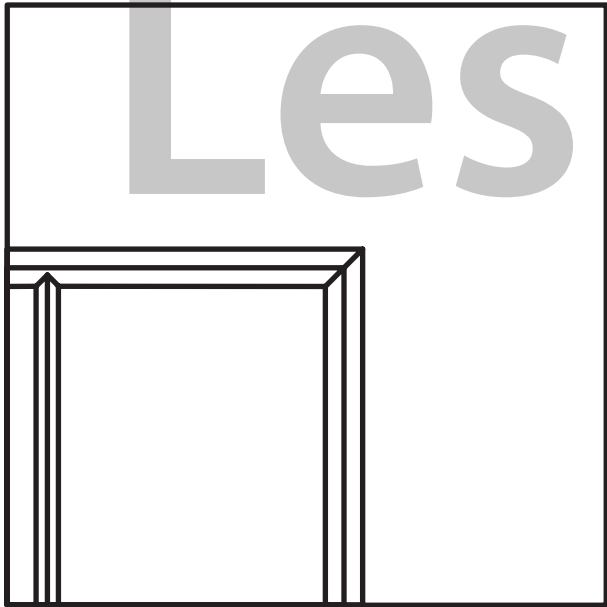
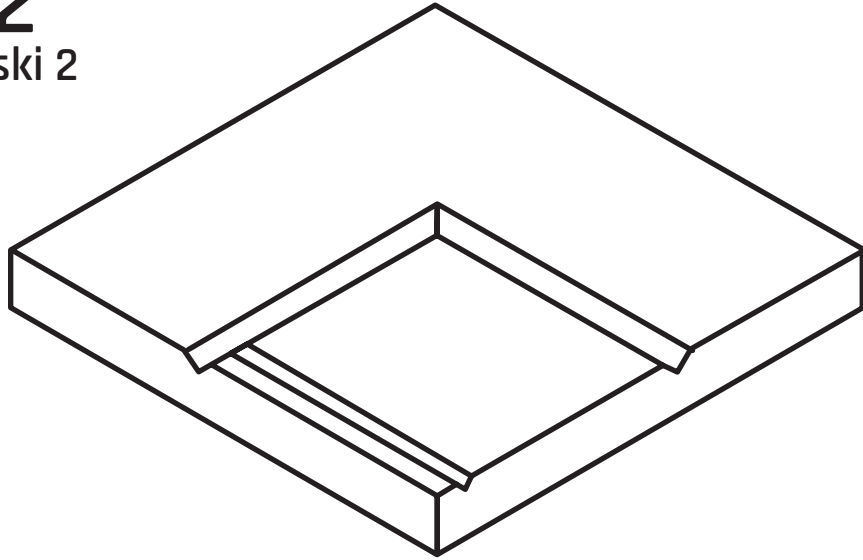

65



Front

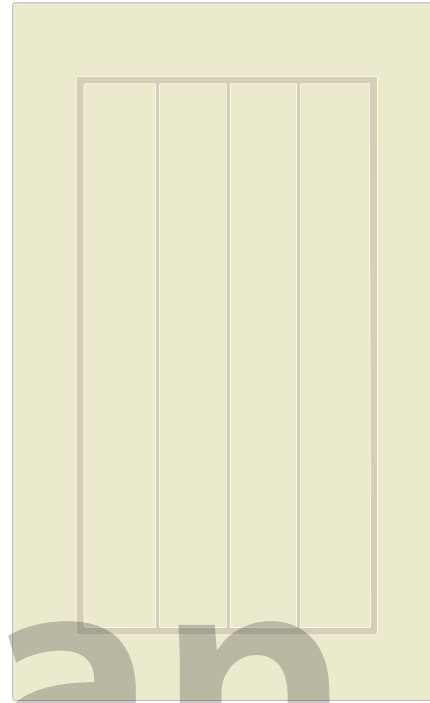

Witryna Szpros

Szuflady

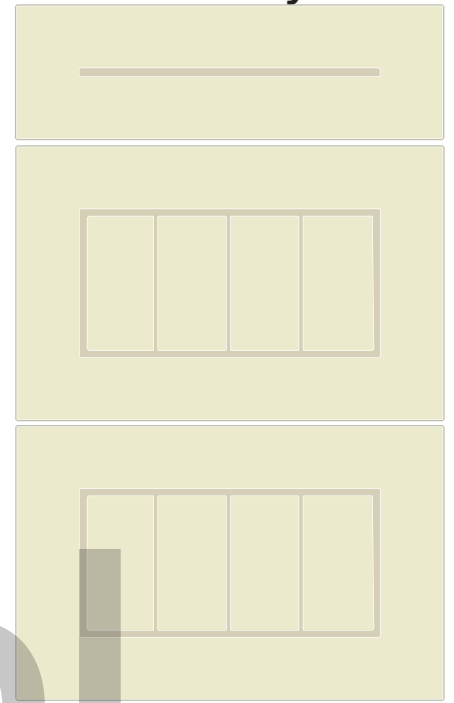

Witryna

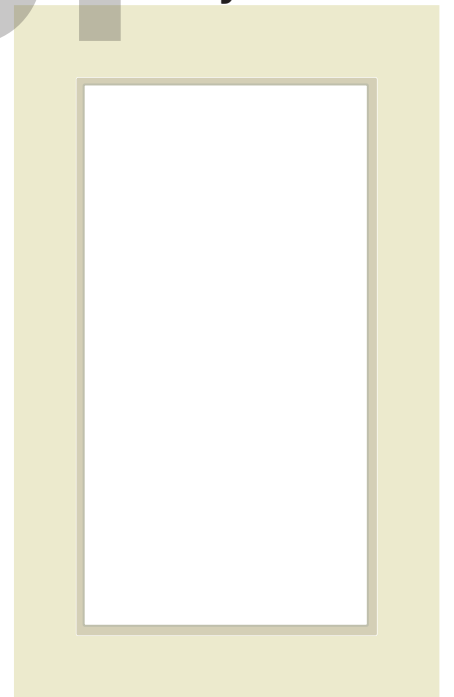
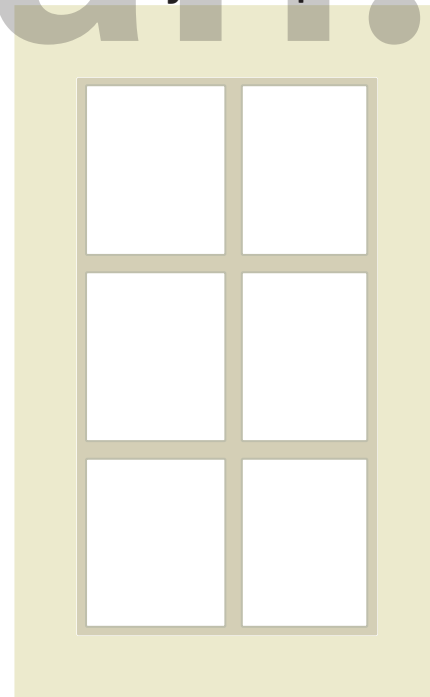

P4
Paski 4

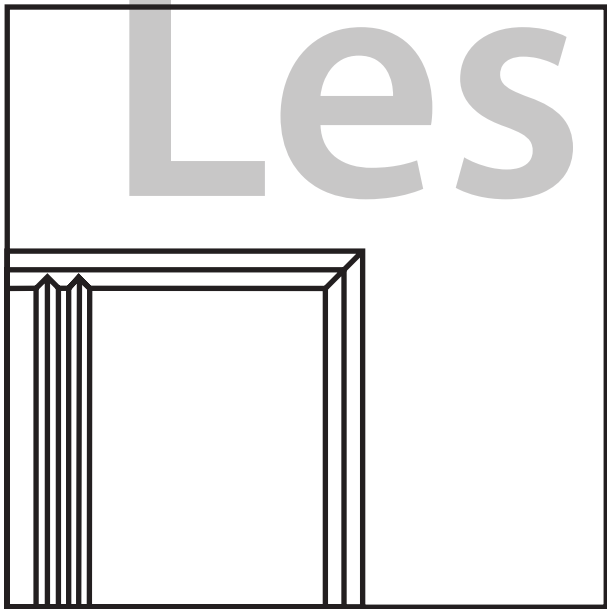
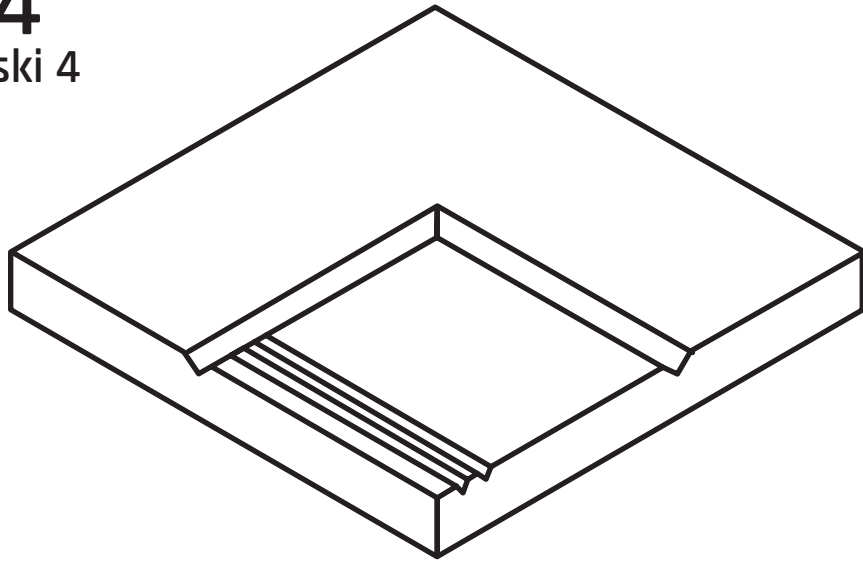

65



19

Front

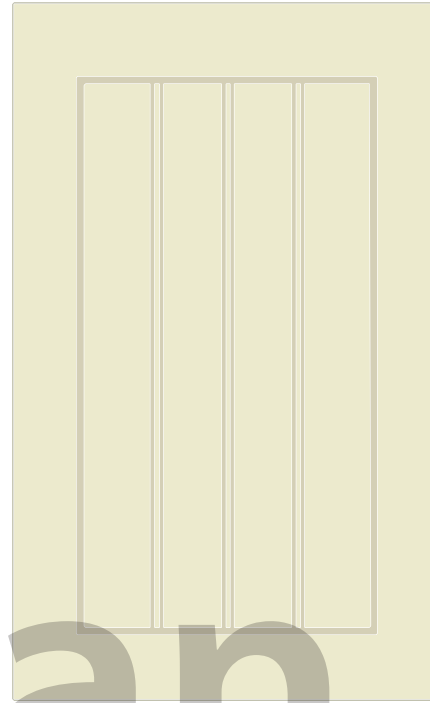

Witryna Szpros

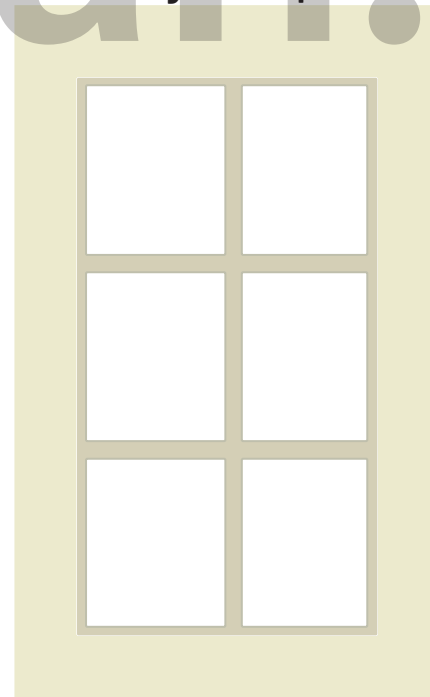

Szuflady

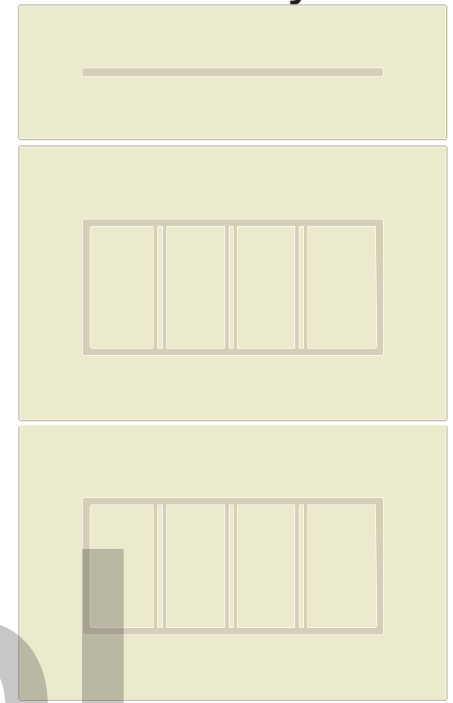

Witryna

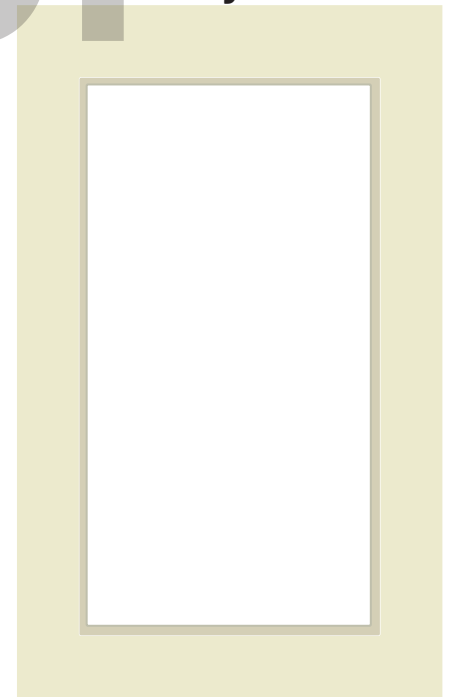

R1
Ramka 1

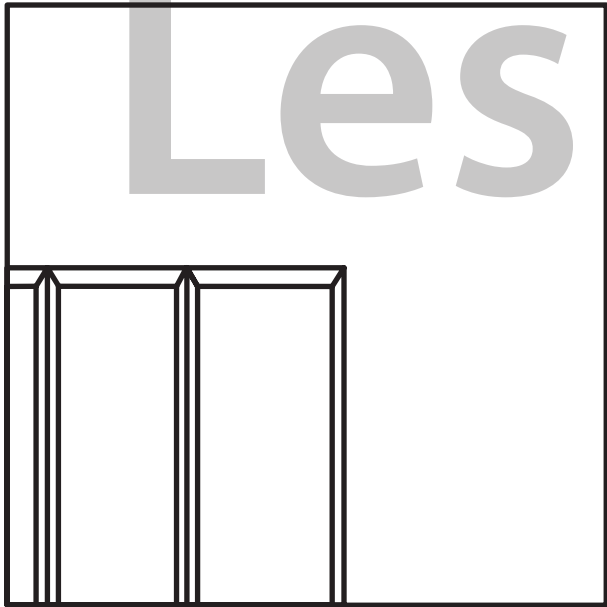
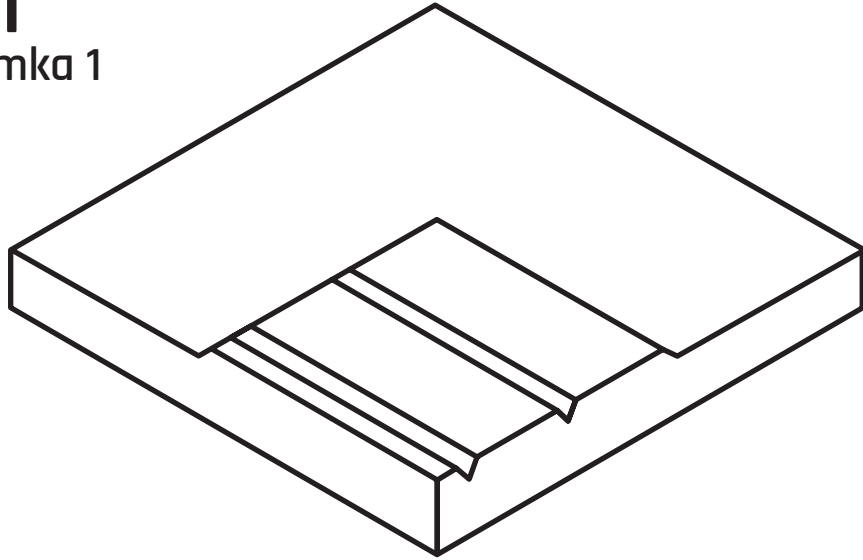

Front

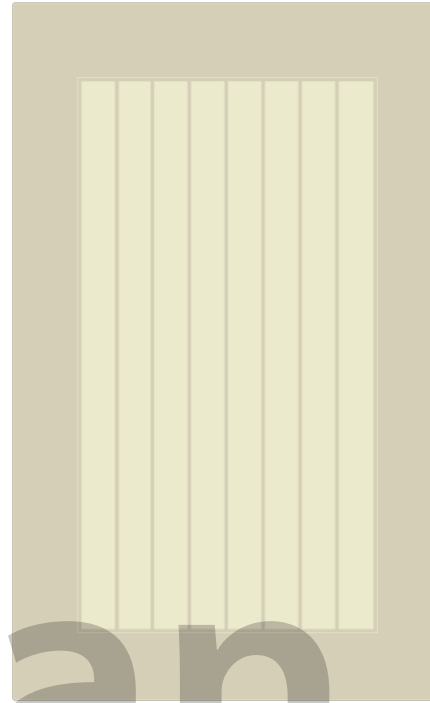

Witryna Szpros

Szuflady

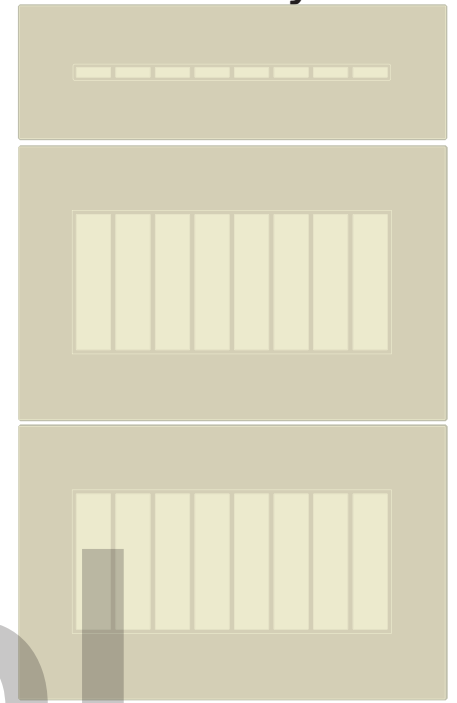

Witryna

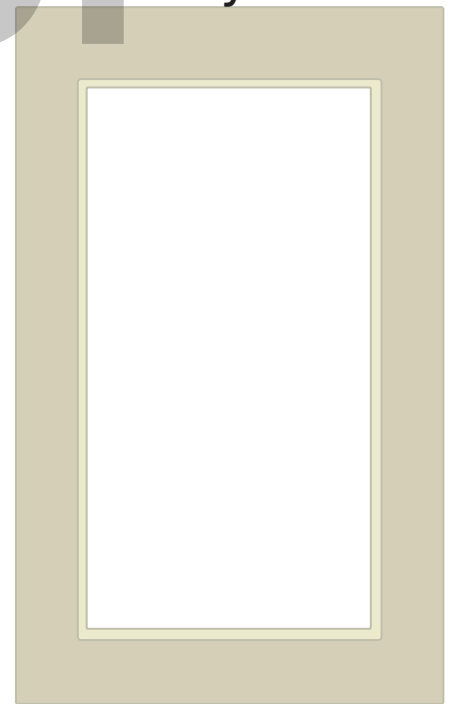
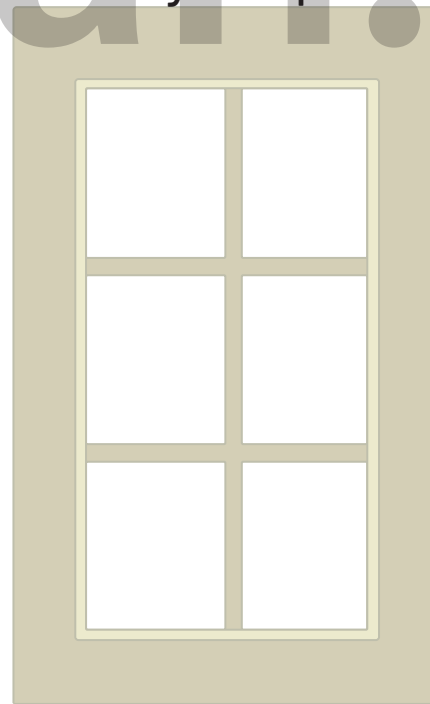

R2
Ramka 2

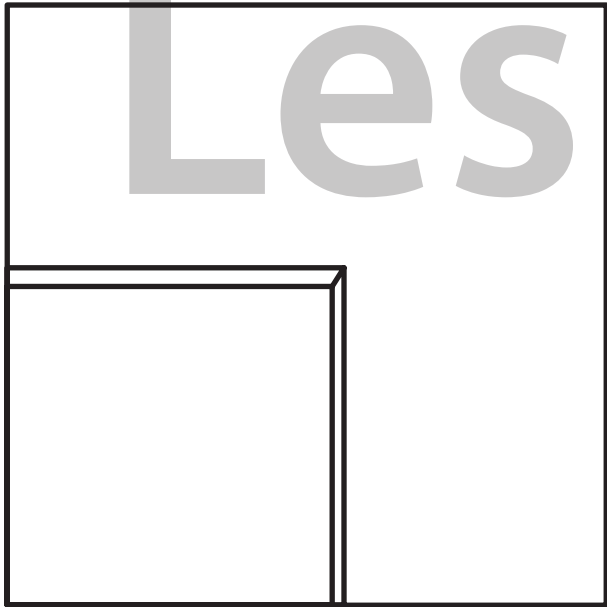
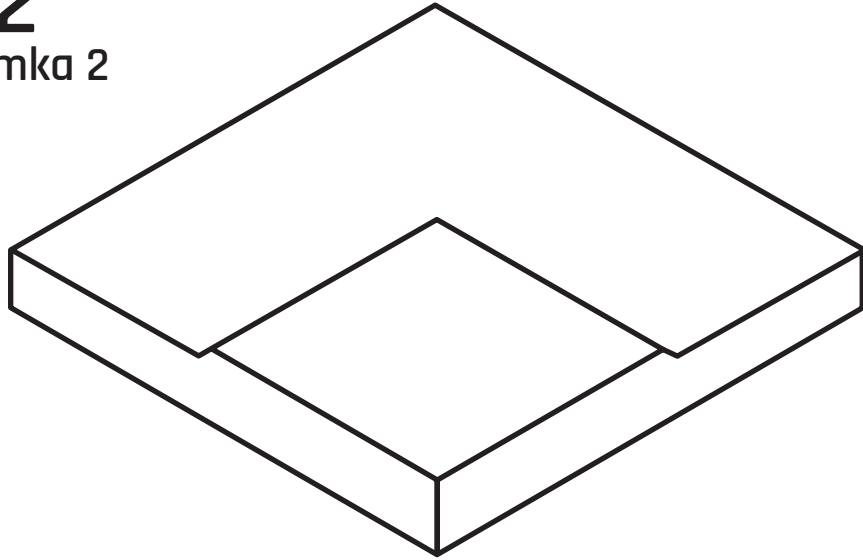

Front

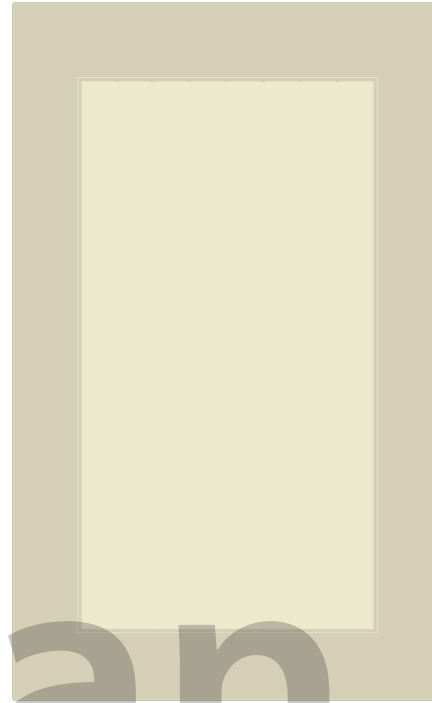

Witryna Szpros

Szuflady

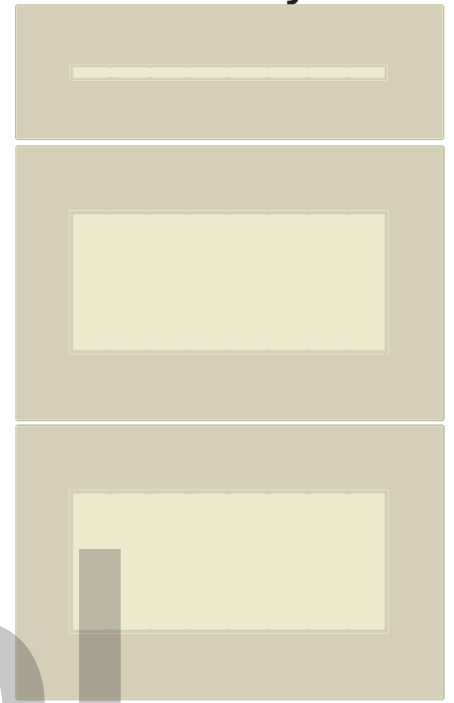

Witryna

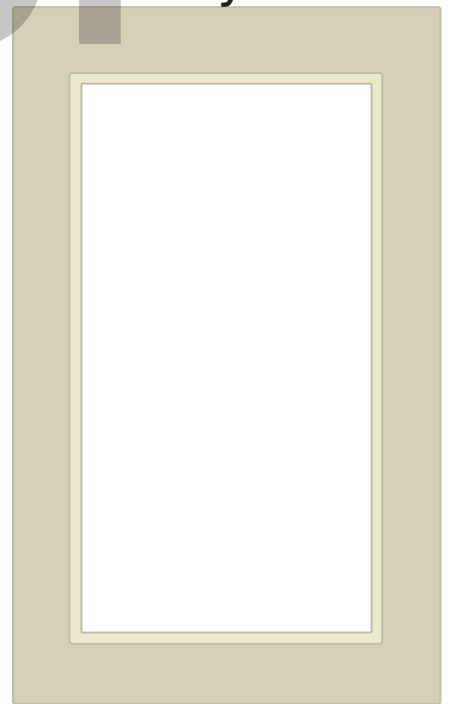
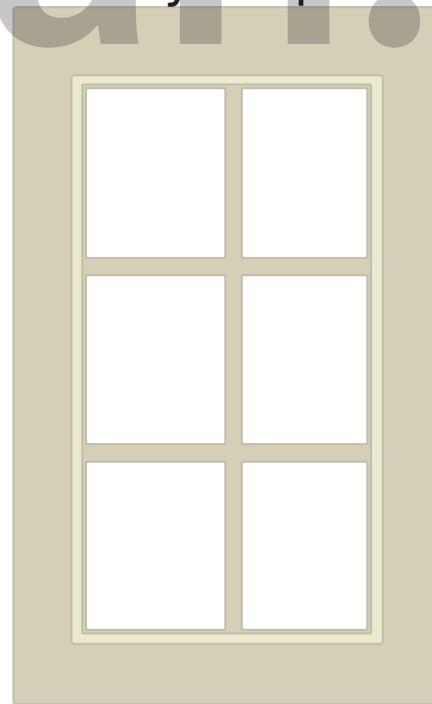

R3
Ramka 3

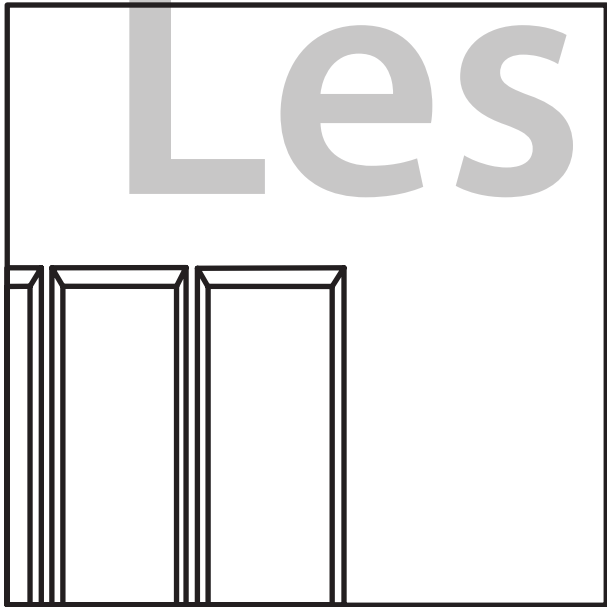
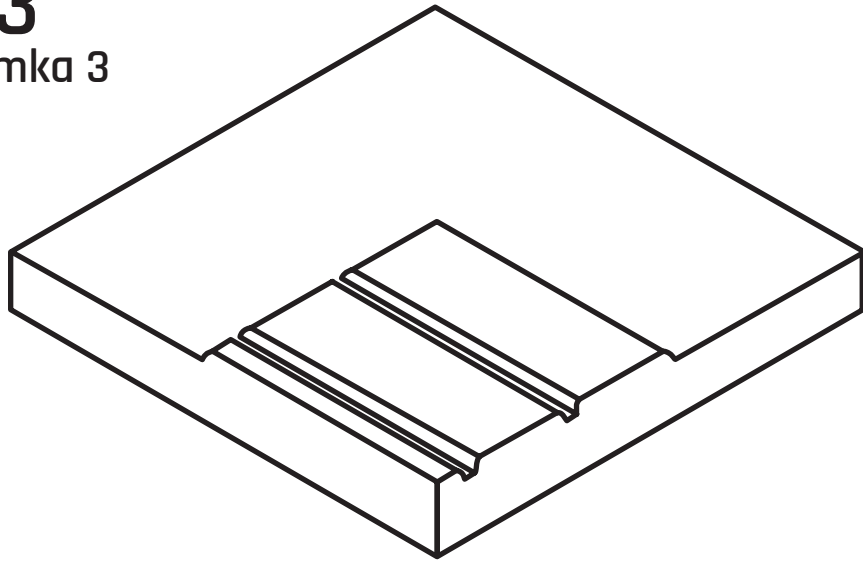

Front

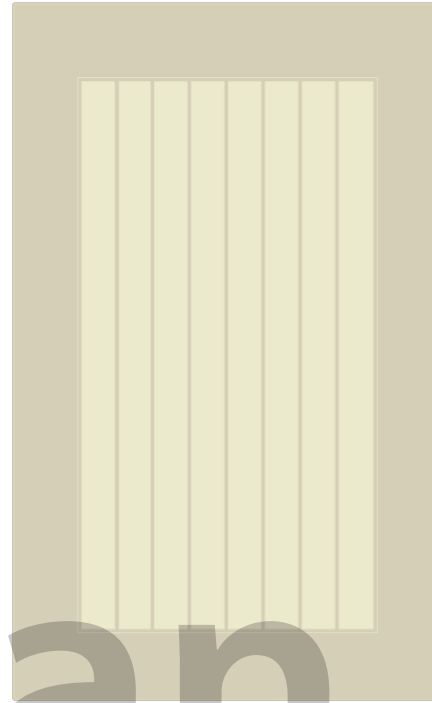

Witryna Szpros

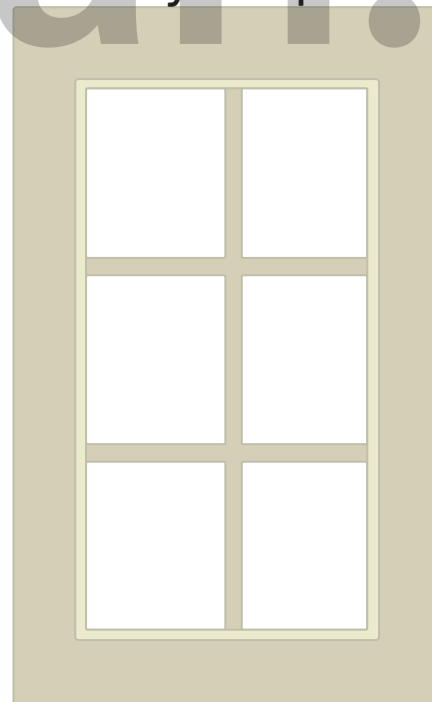

Szuflady

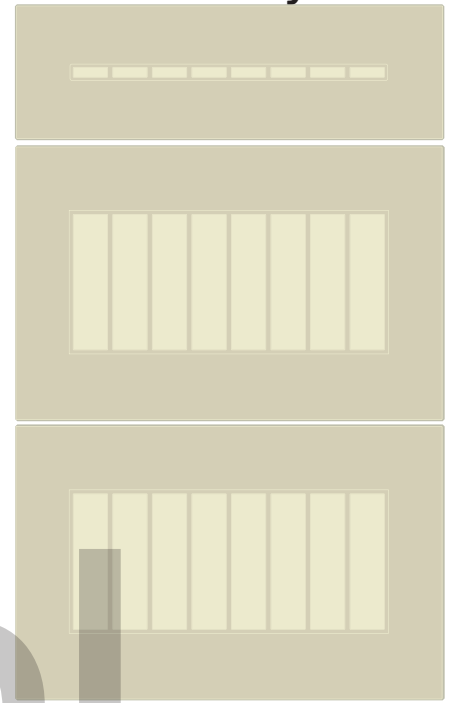

Witryna

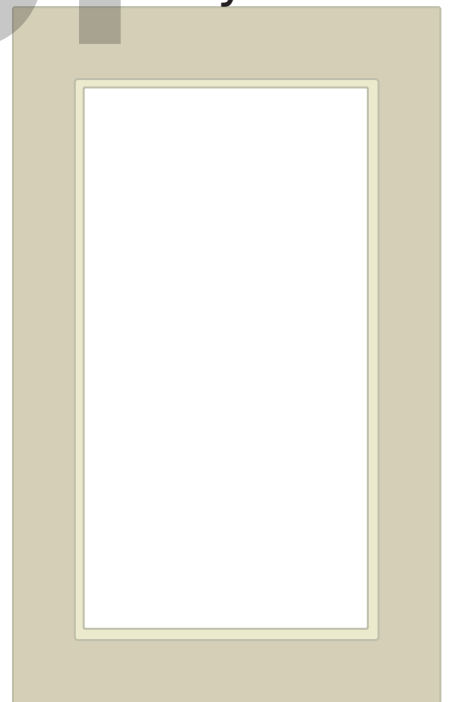

R4

Ramka 4

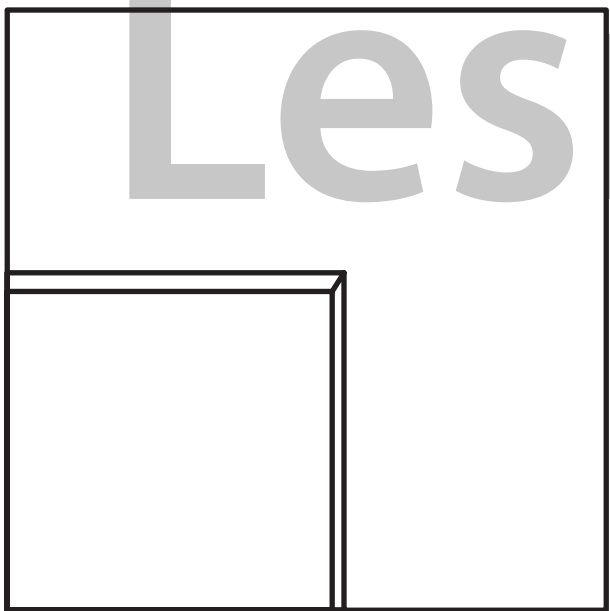
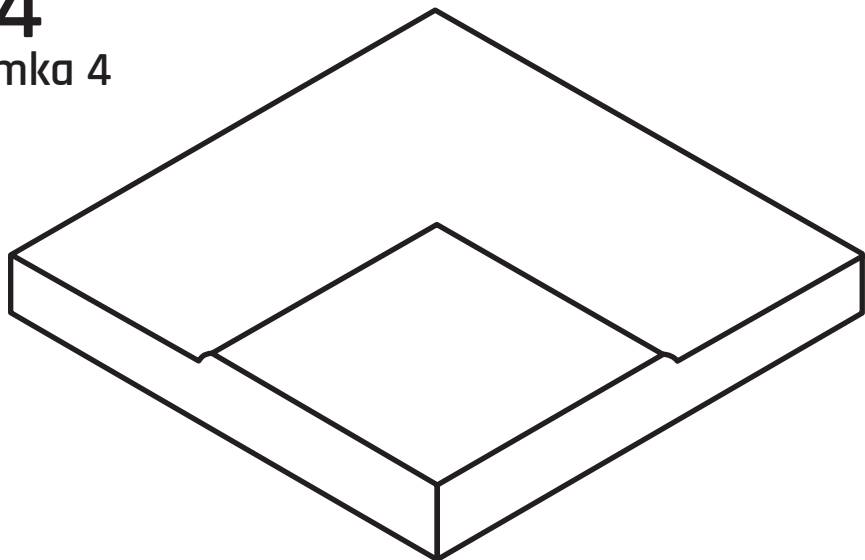

Front

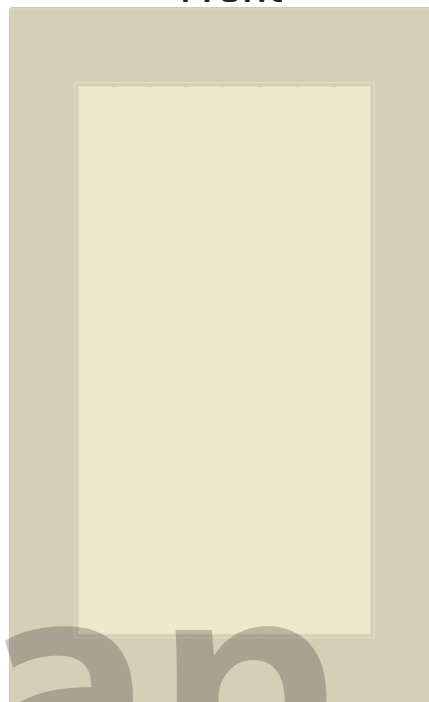

Witryna Szpros

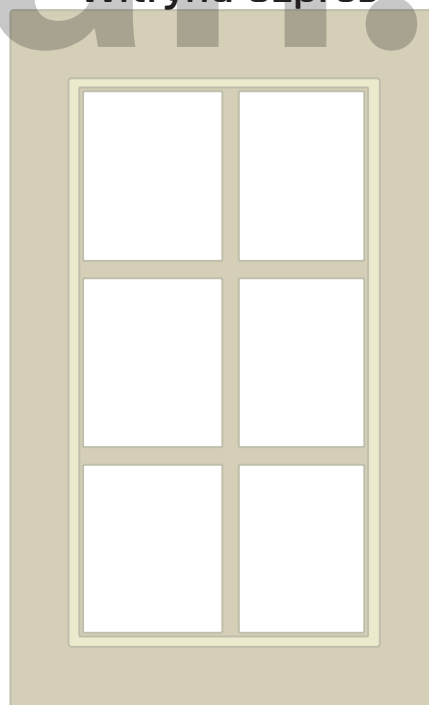

Szuflady

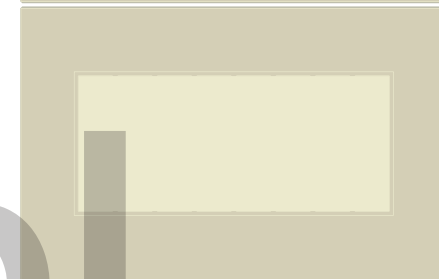
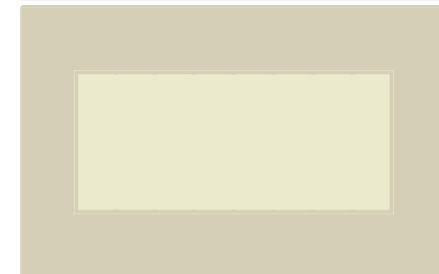
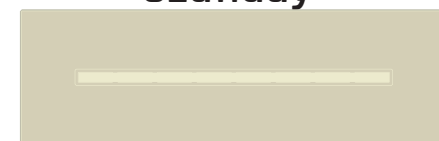

Witryna

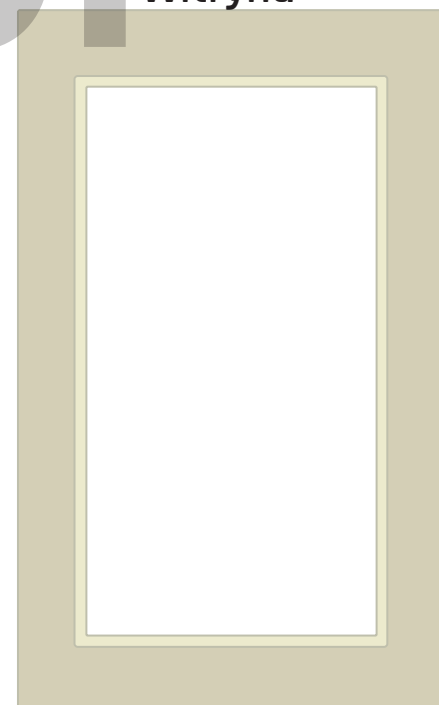

ER1

Ekran Ramiak 1

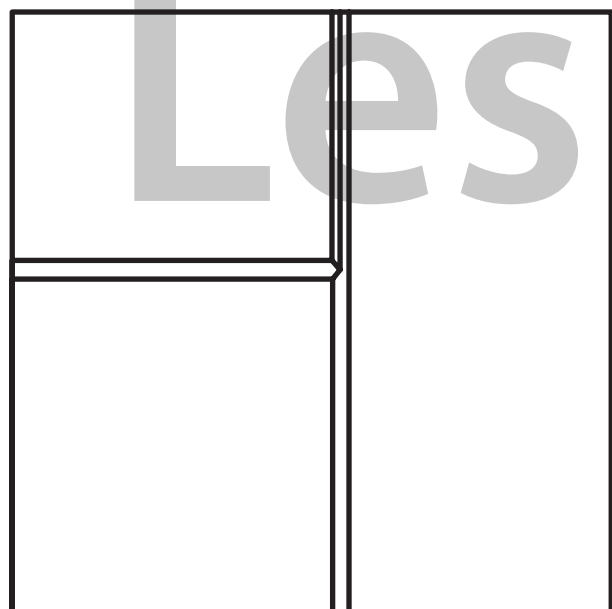
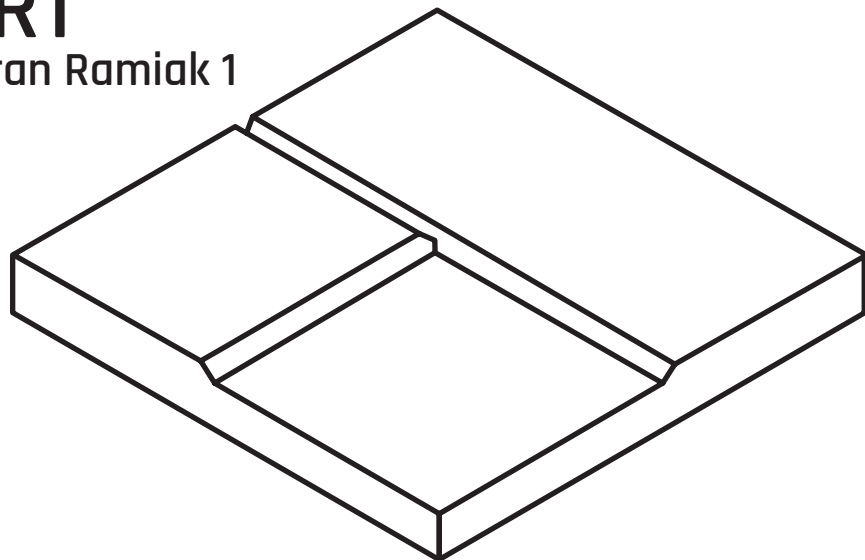

19

65



Front

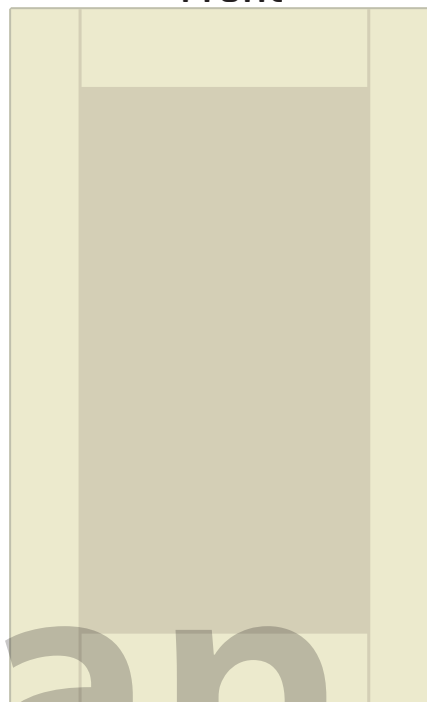

Witryna Szpros

Szuflady

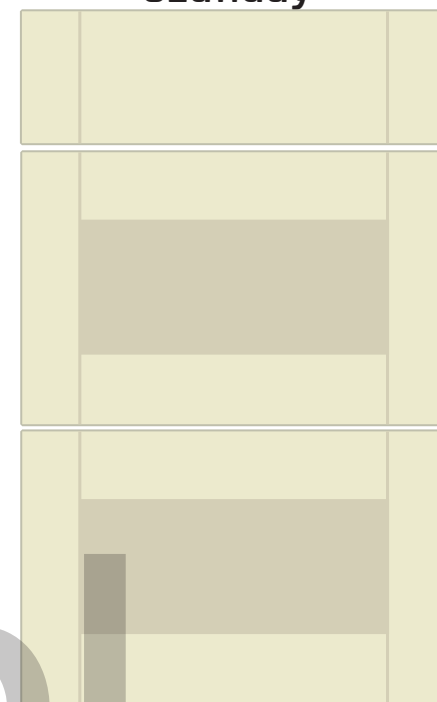

Witryna

ER2

Ekran Ramiak 2

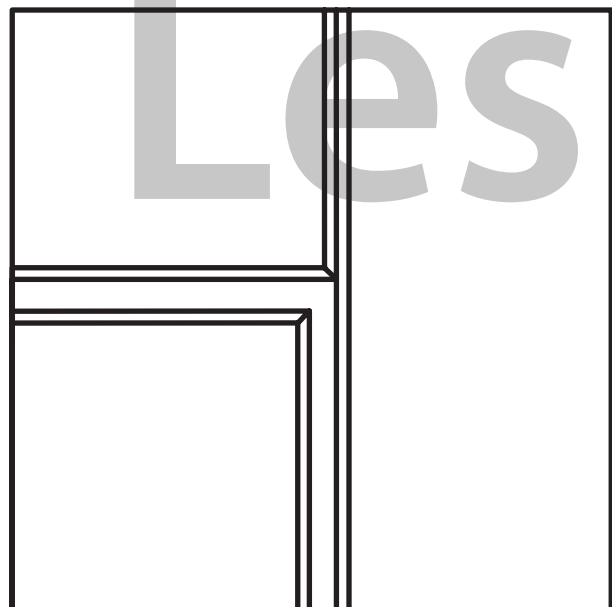
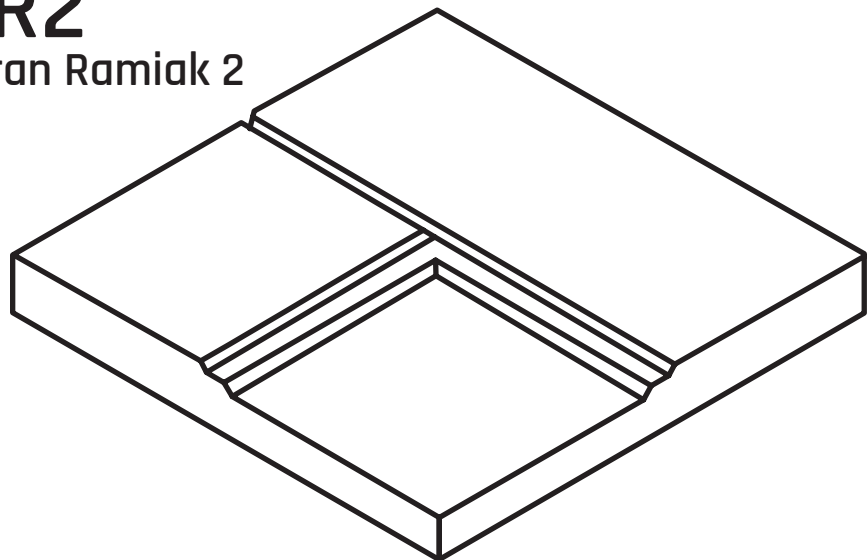

65



19

Front

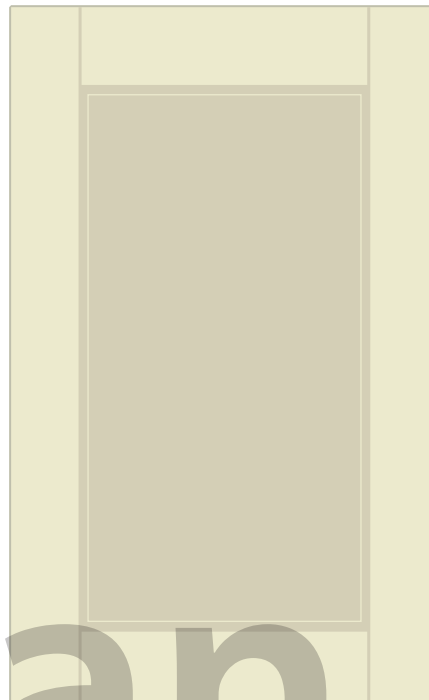

Witryna Szpros

Szuflady

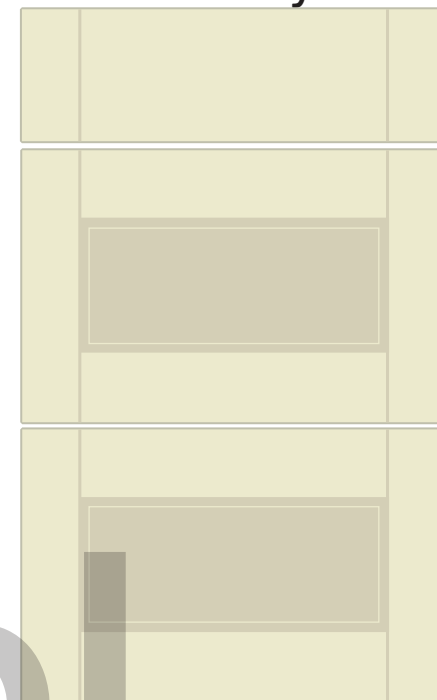

Witryna

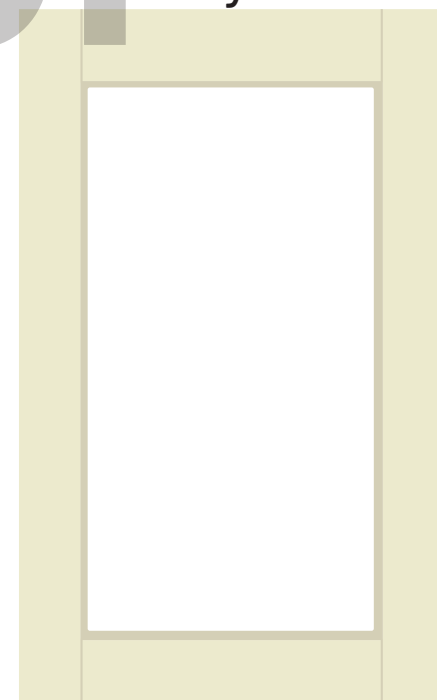
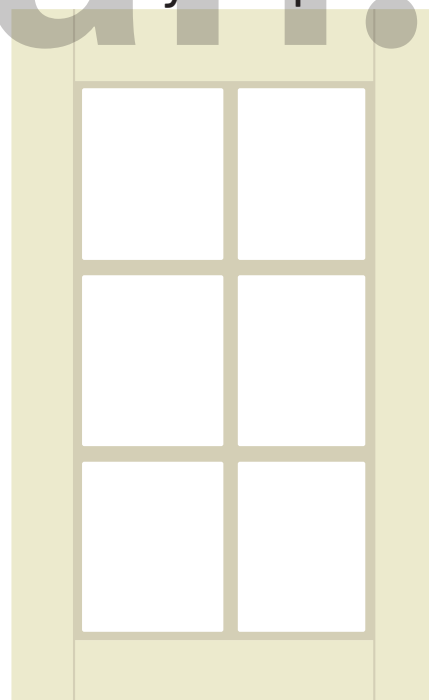

ER3

Ekran Ramiak 3

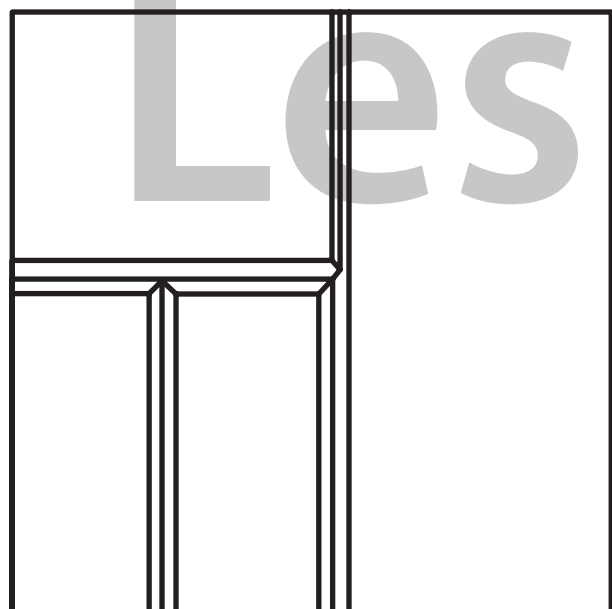
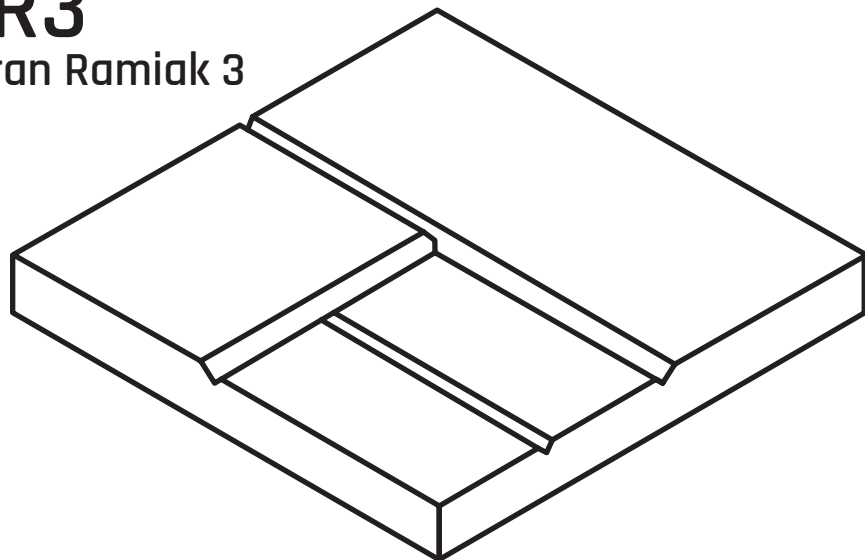

65



19

Front

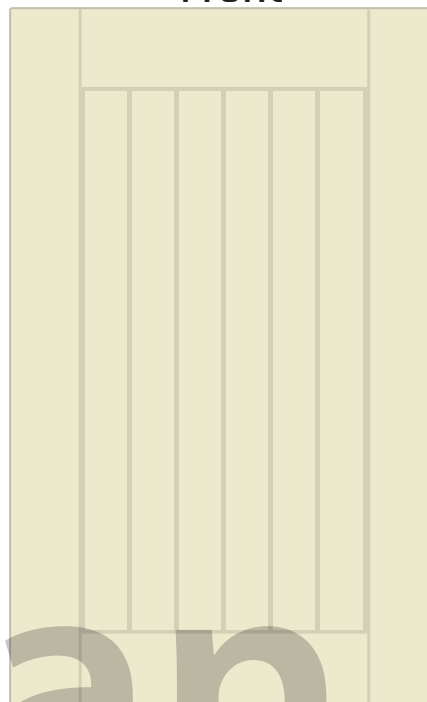

Witryna Szpros

Szuflady

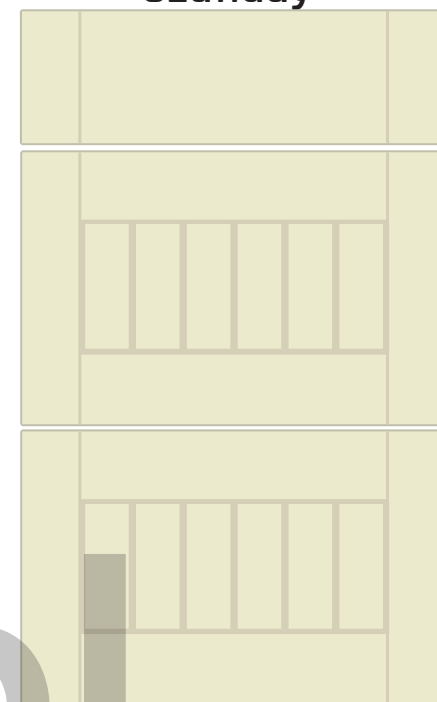

Witryna

Lesman.pl

ER4

Ekran Ramiak 4

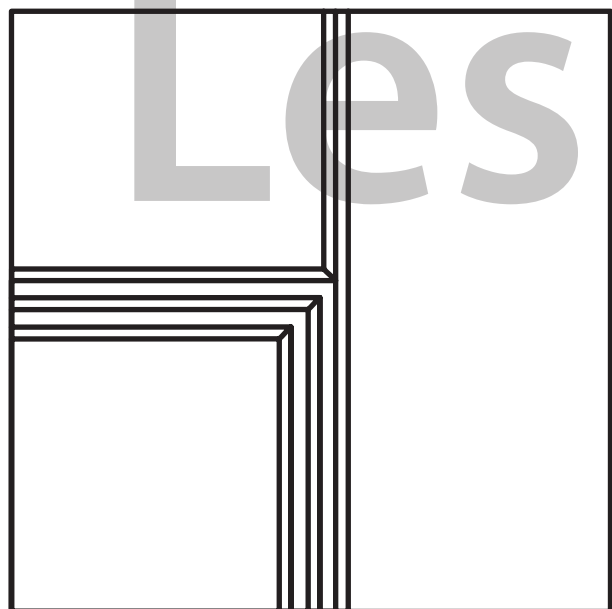
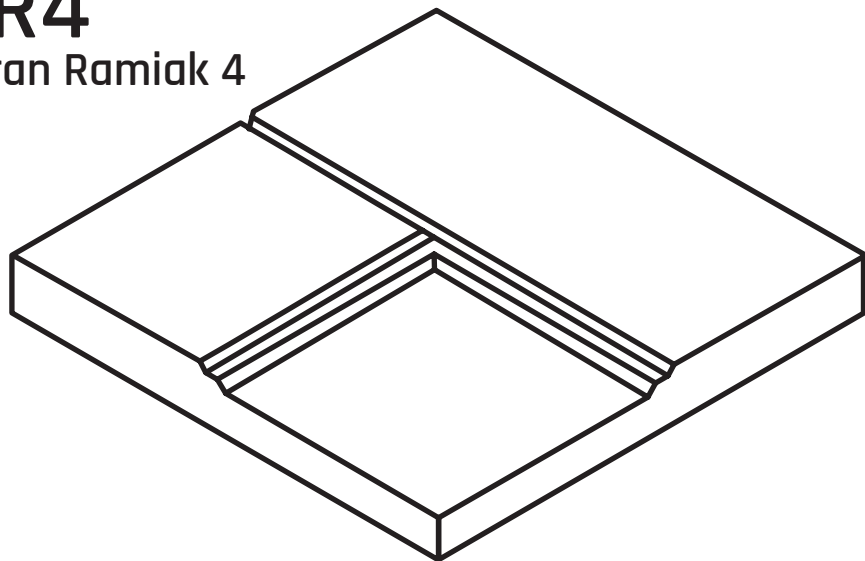

65



19

Front

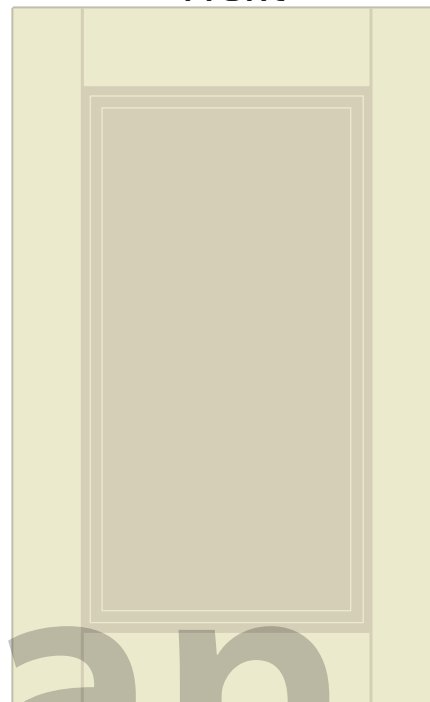

Witryna Szpros

Szuflady

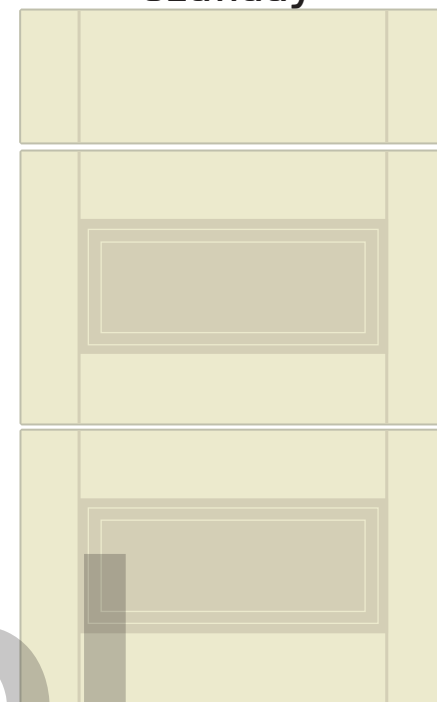

Witryna

Lesman.pl

ES1

Ekran skos 1

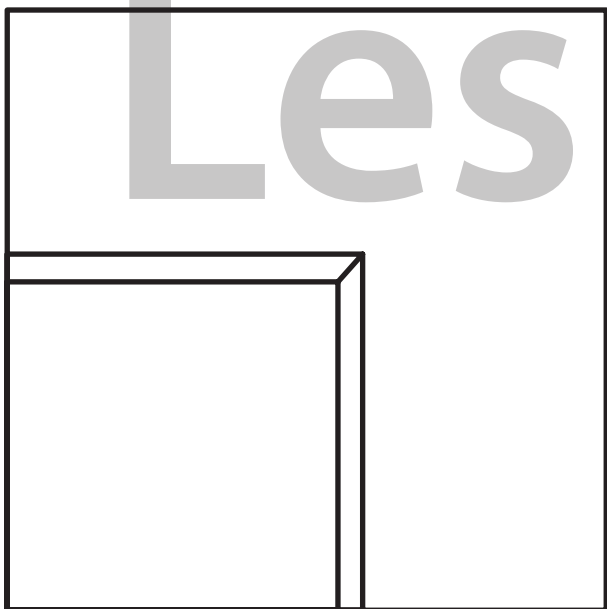
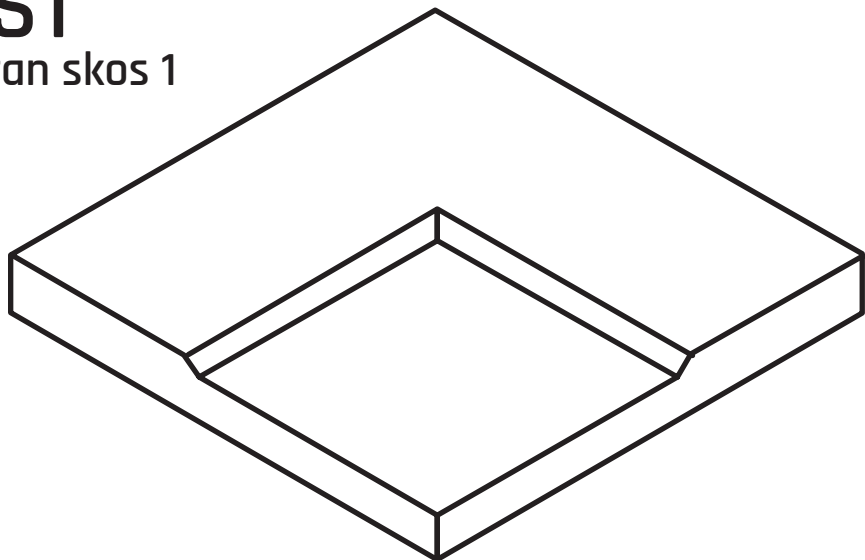

65



19

Front

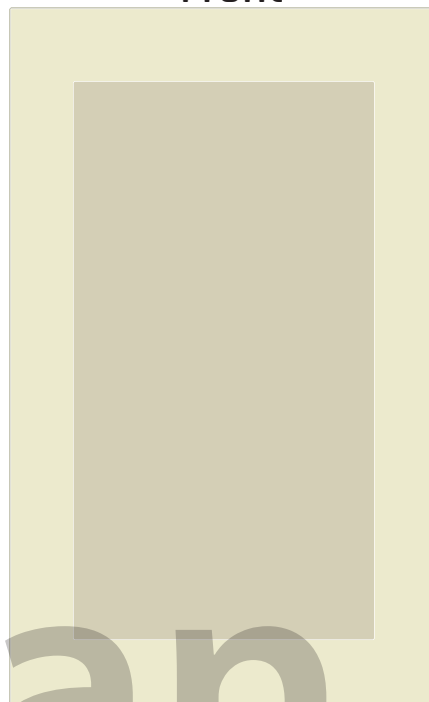

Witryna Szpros

Szuflady

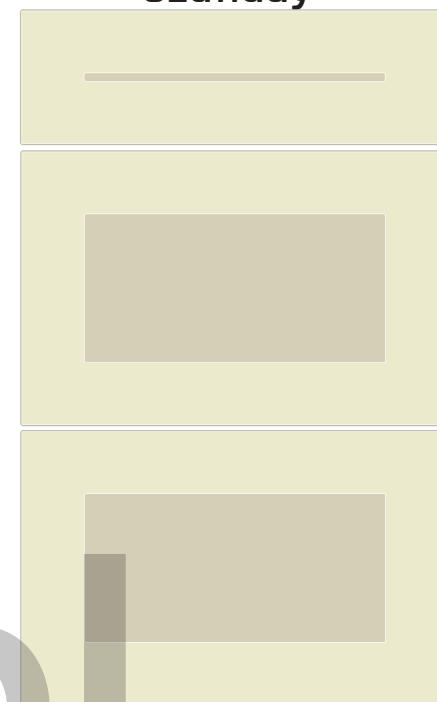

Witryna

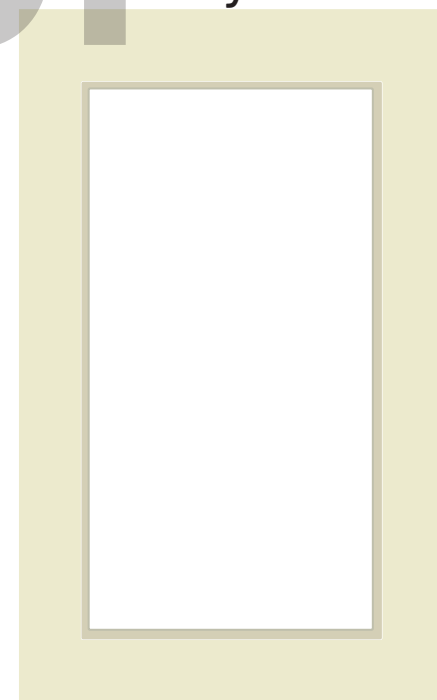
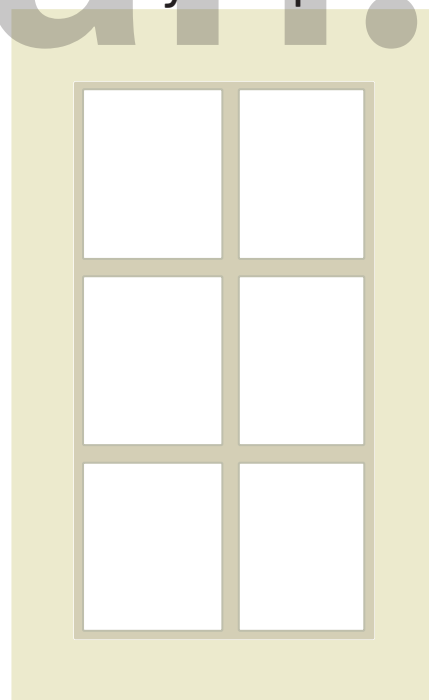

ES2

Ekran skos 2

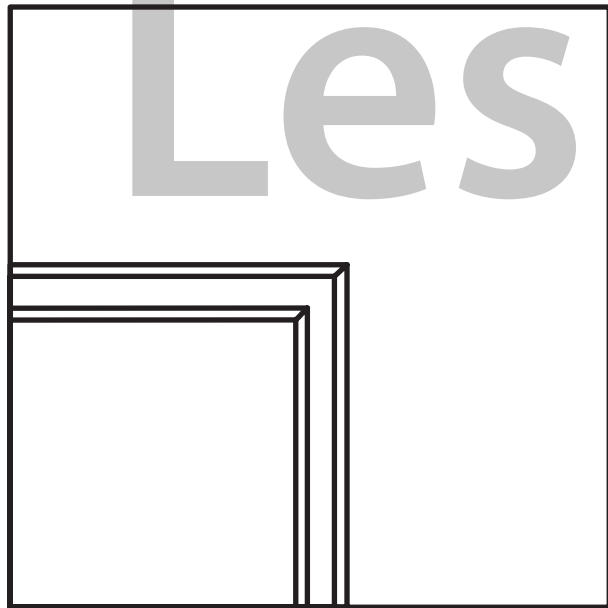
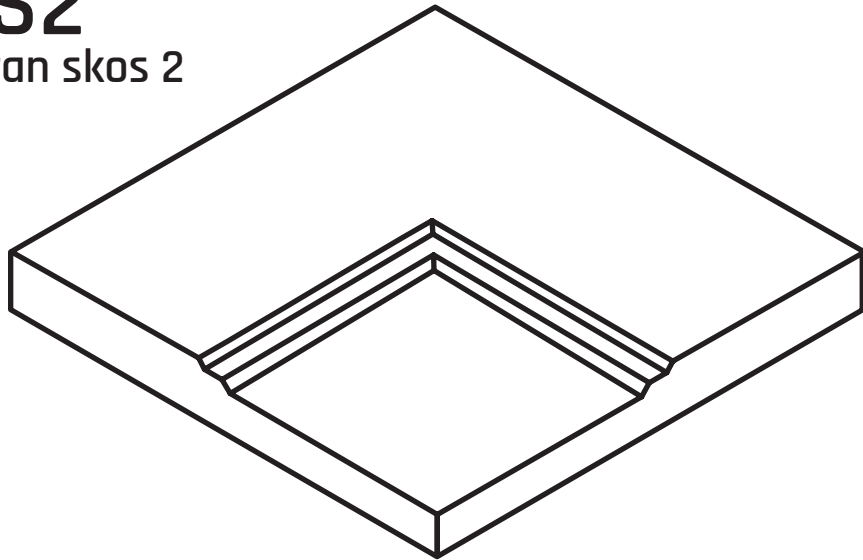

65



19

Front

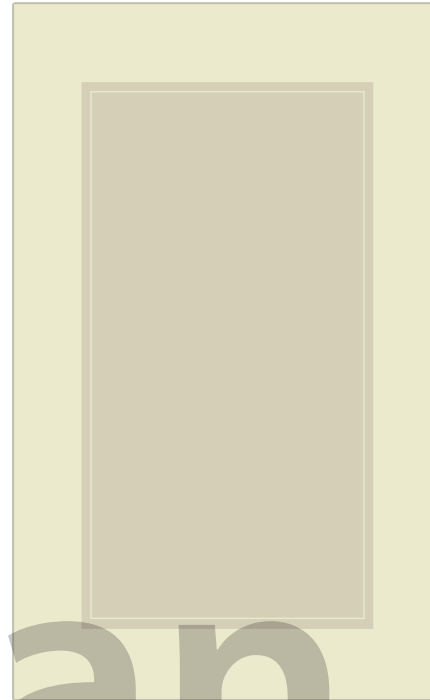

Witryna Szpros

Szuflady

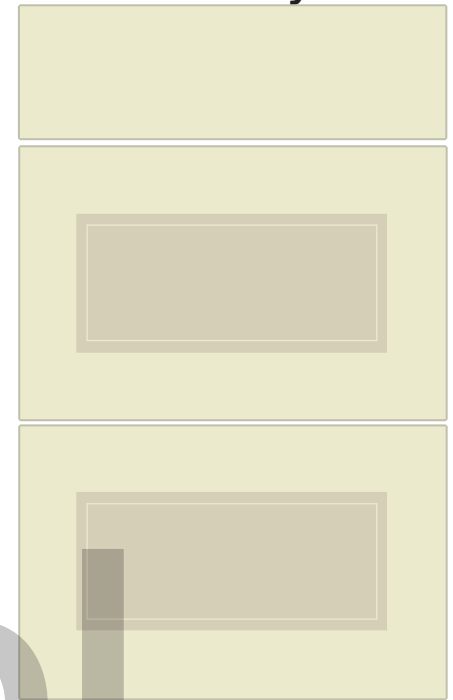

Witryna

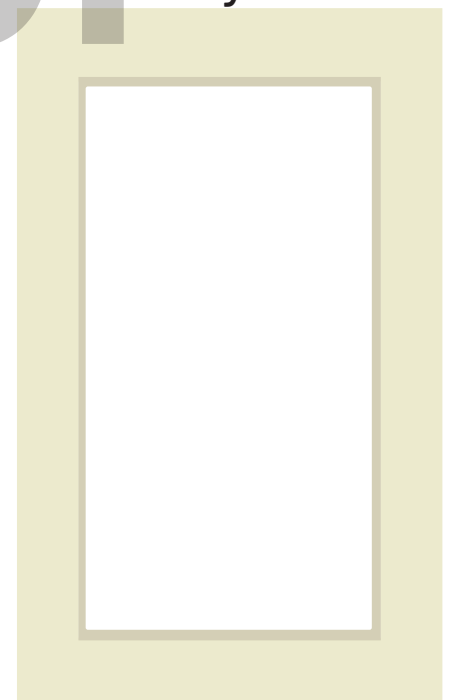
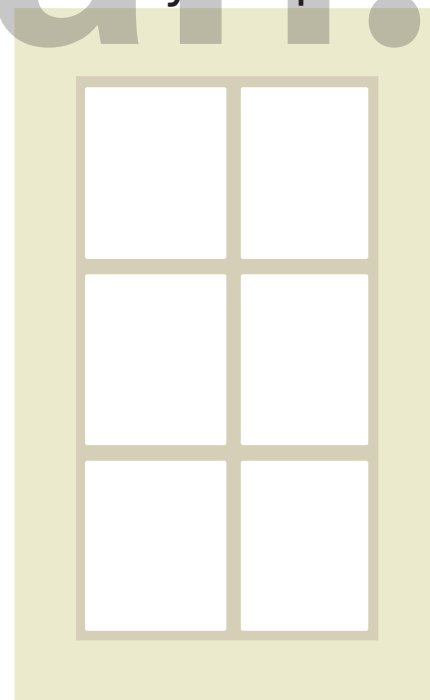

ES3

Ekran skos 3

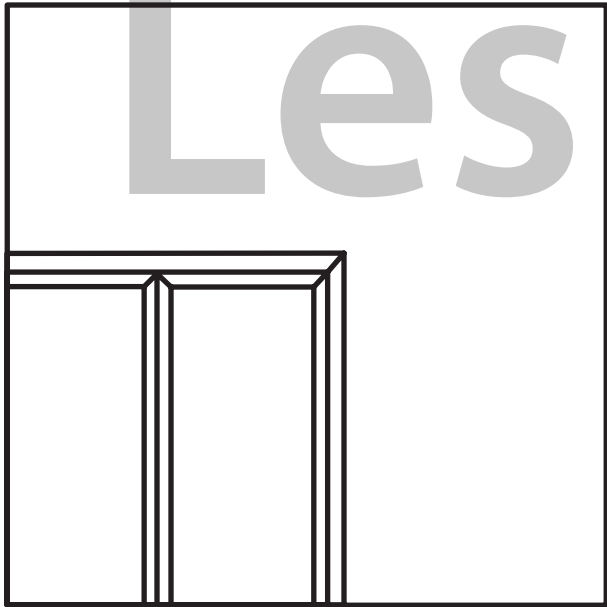
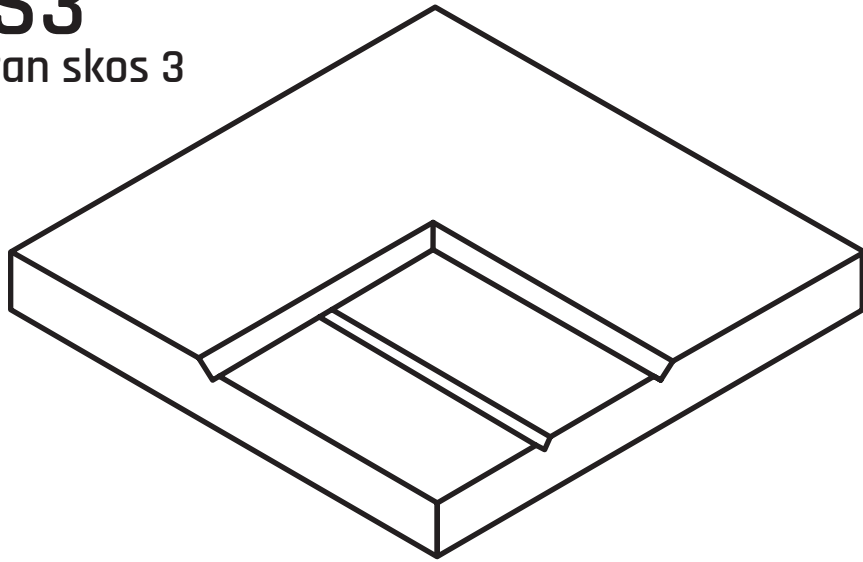

65



19

Front

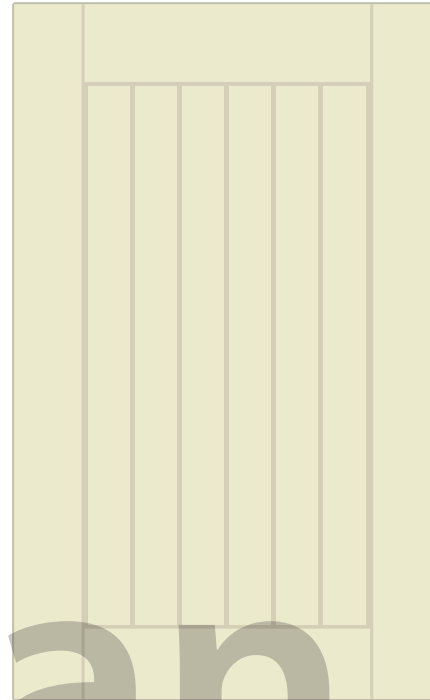

Witryna Szpros

Szuflady

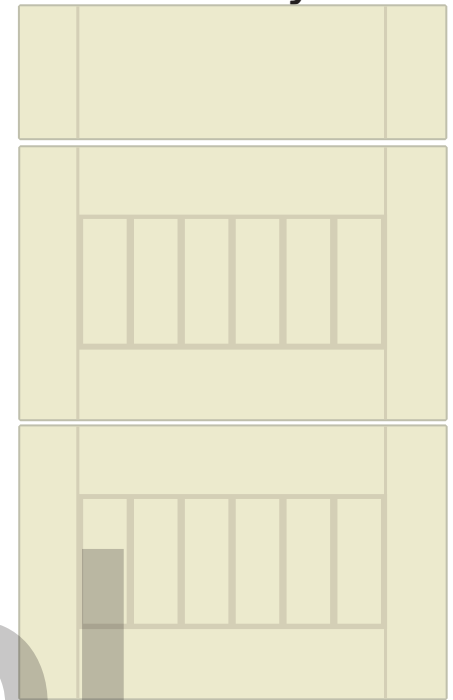

Witryna

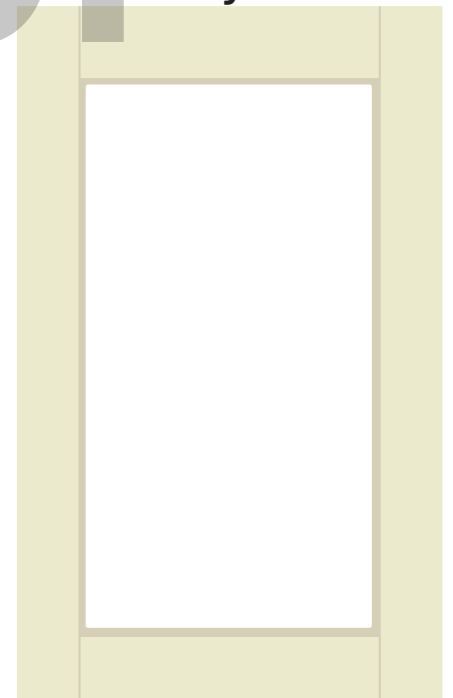

ES4

Ekran skos 4

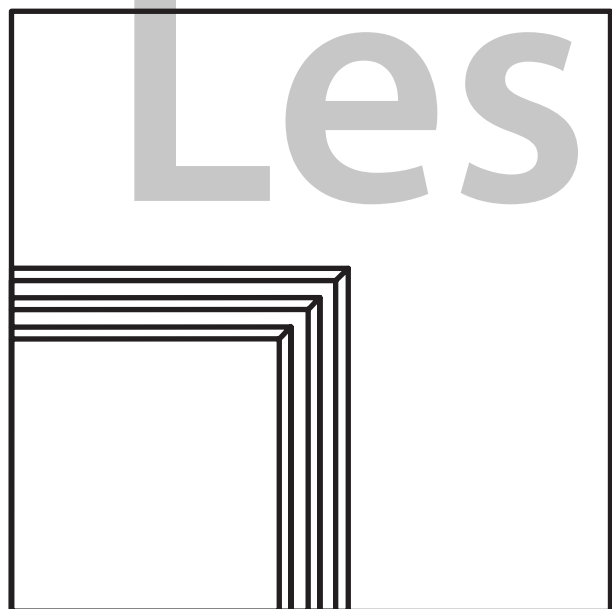
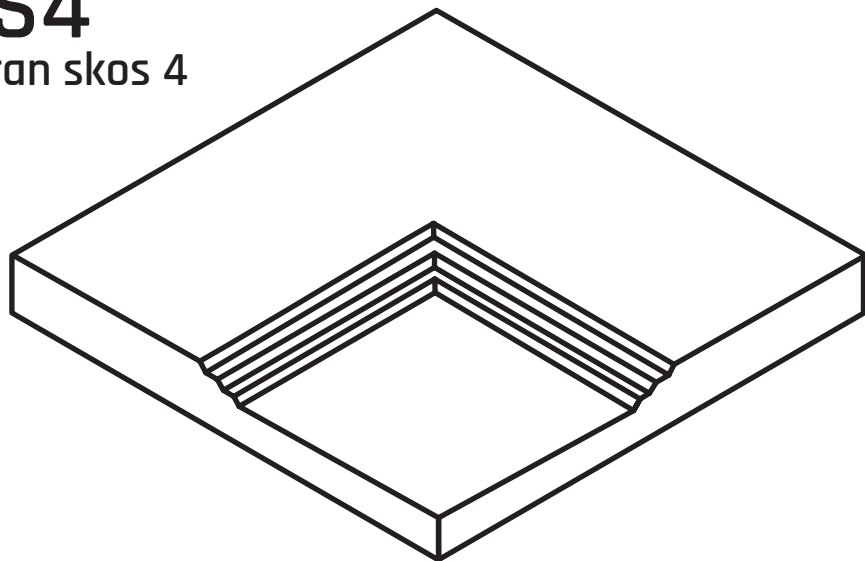

65



19

Front

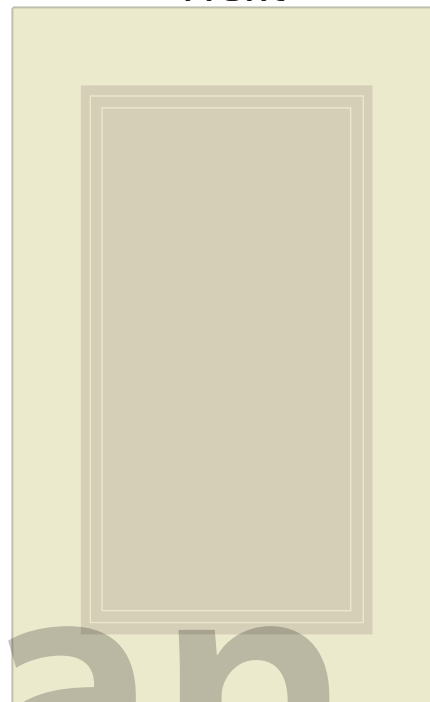

Witryna Szpros

Szuflady

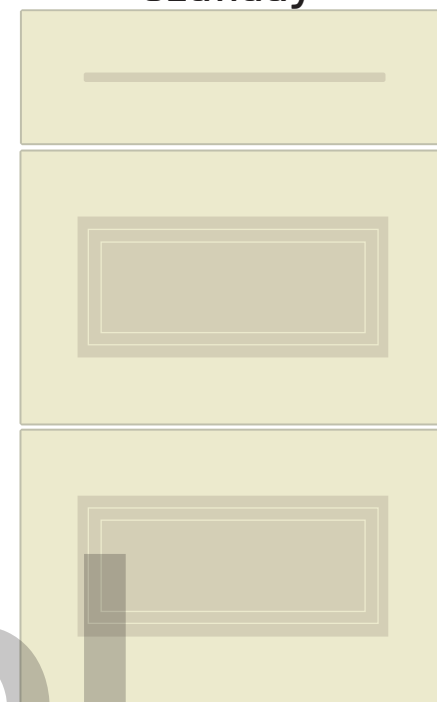

Witryna

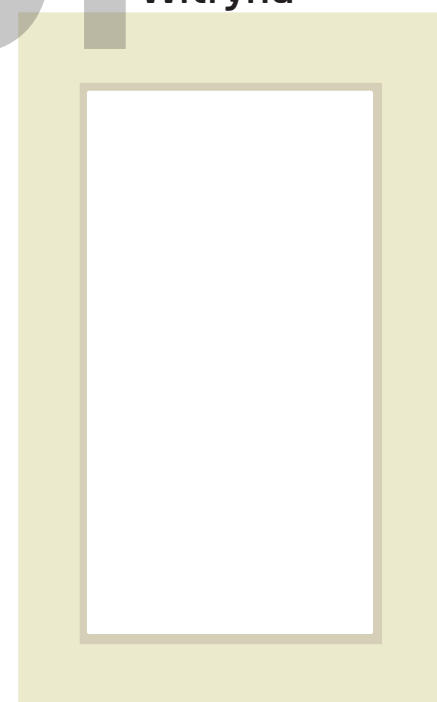
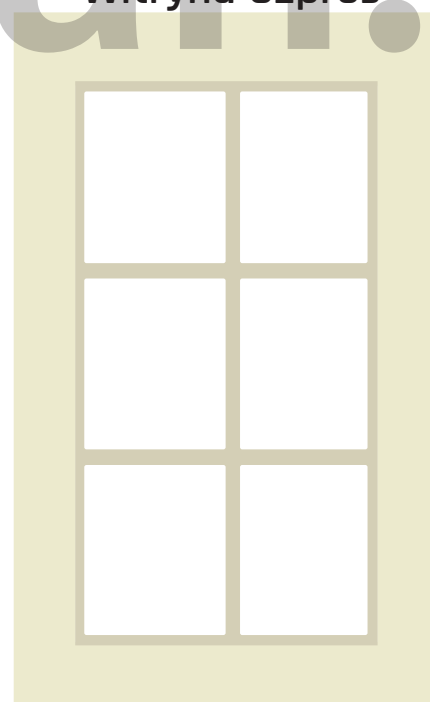

EP1

Ekran Prosty 1

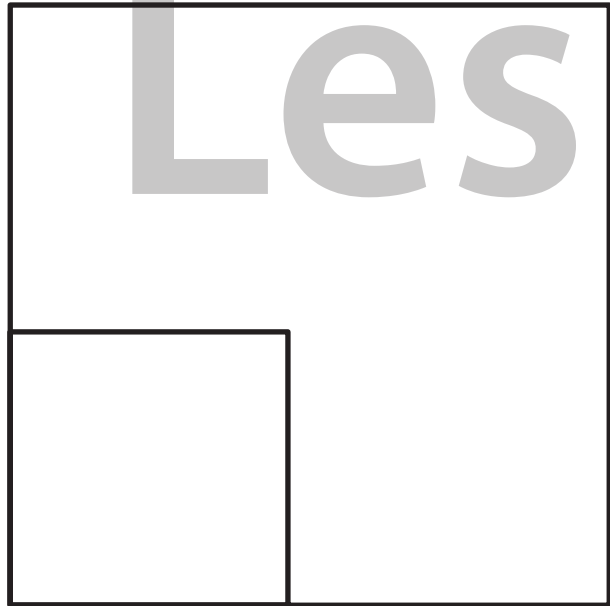
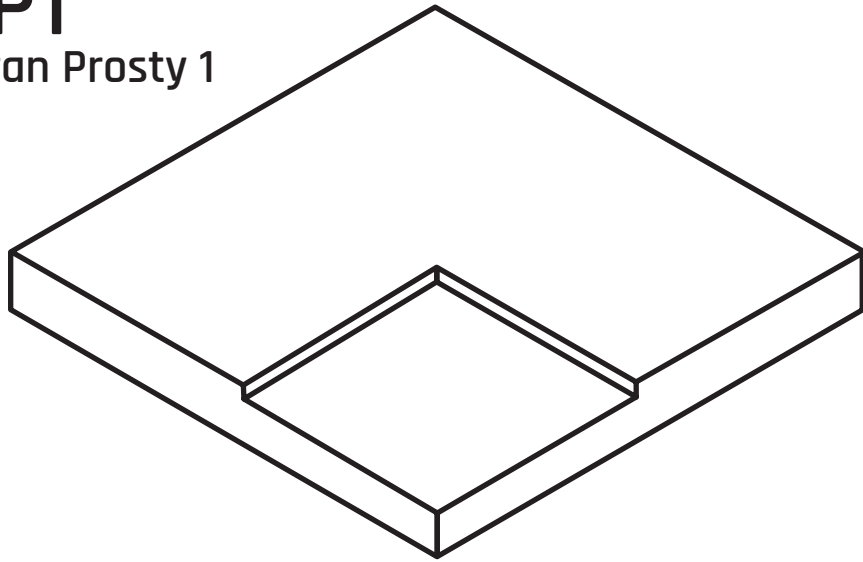

95



19

Front

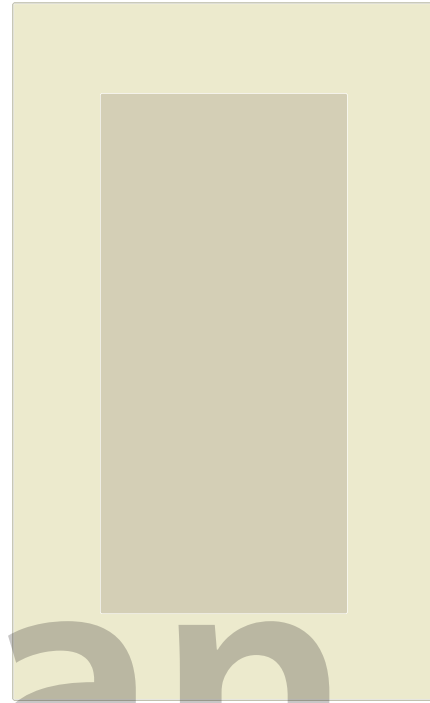

Witryna Szpros

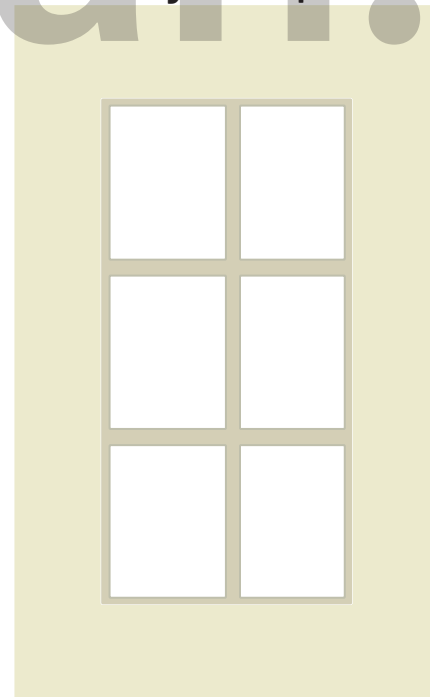

Szuflady

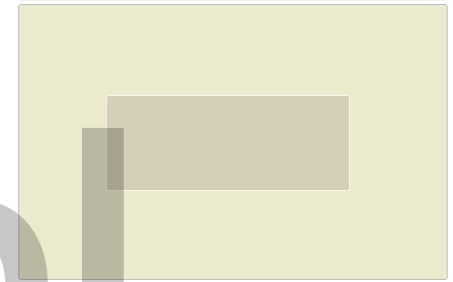
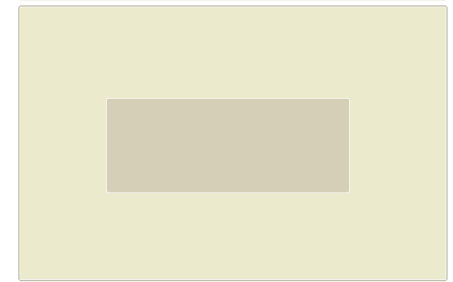

Witryna

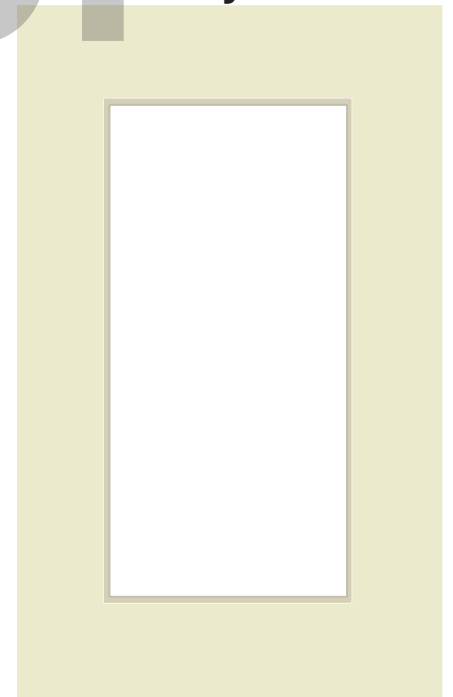

EP2

Ekran Prosty 2

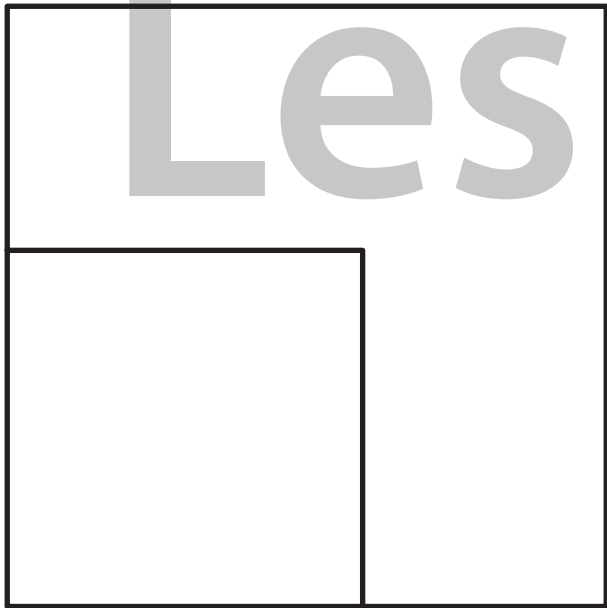
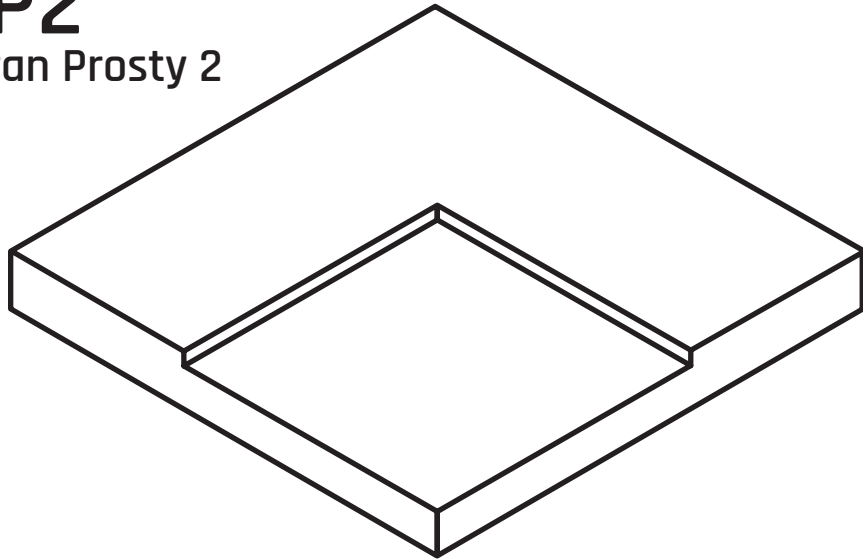

65



19

Front

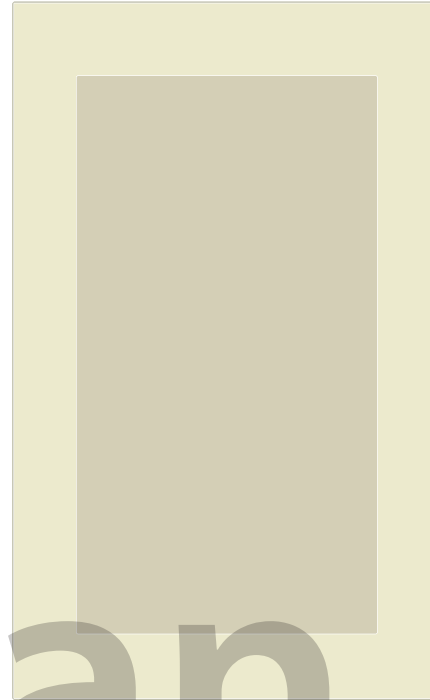

Witryna Szpros

Szuflady

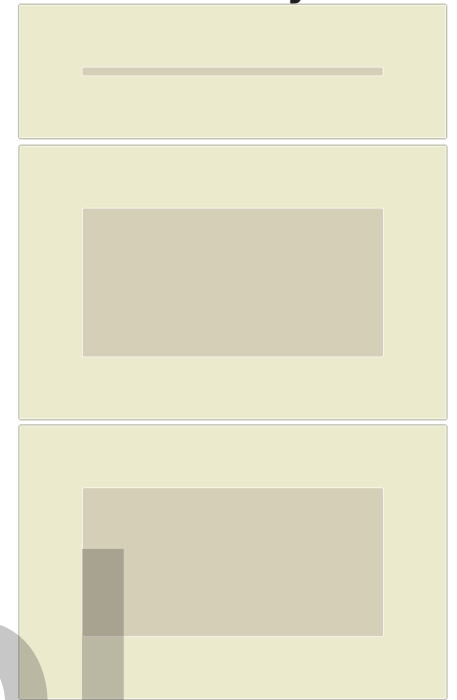

Witryna

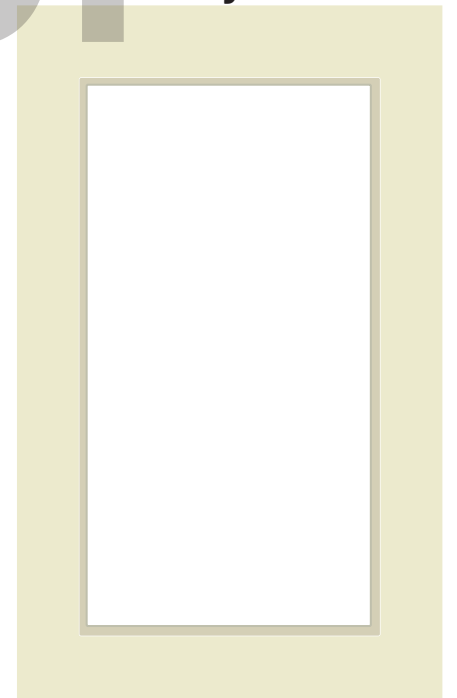
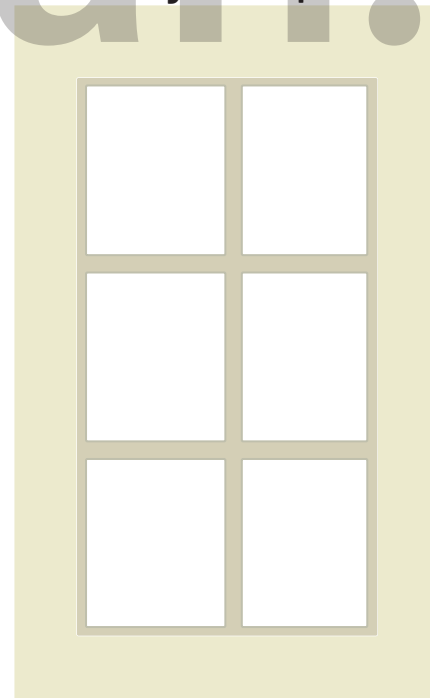

EP3

Ekran Prosty 3

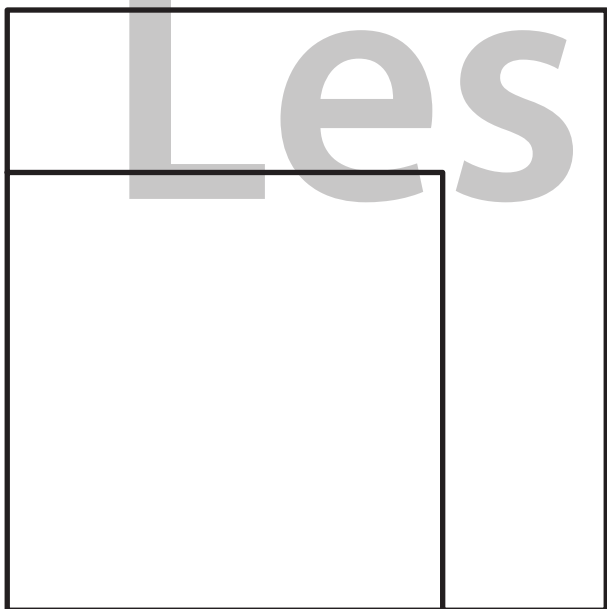
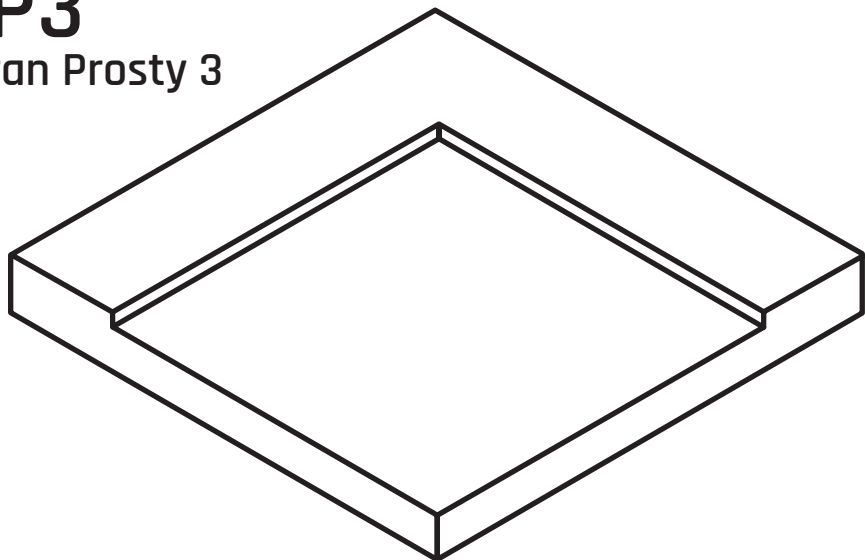

40



Front

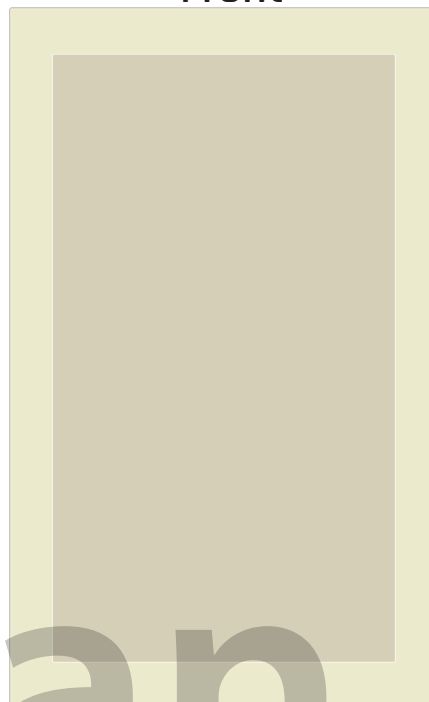

Szuflady

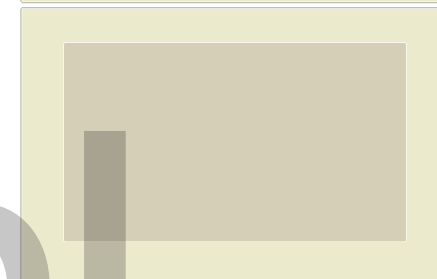
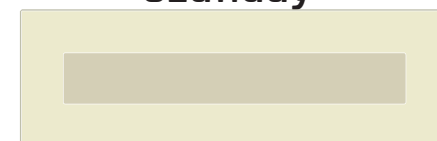

Witryna Szpros

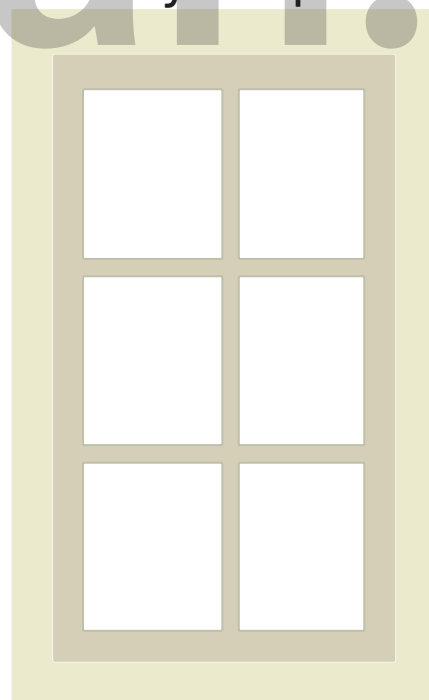

Witryna

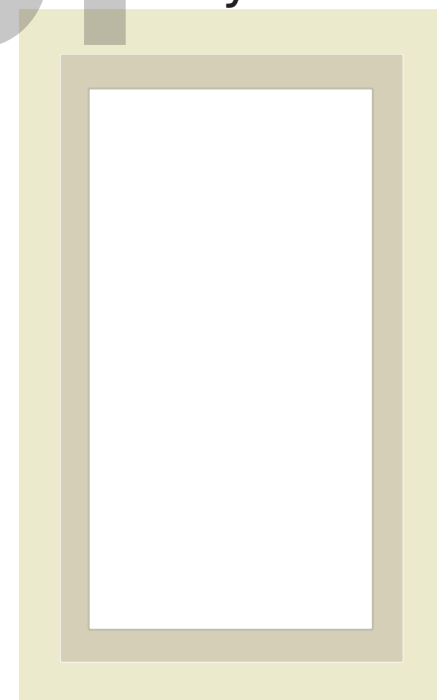

EP4

Ekran Prosty 4

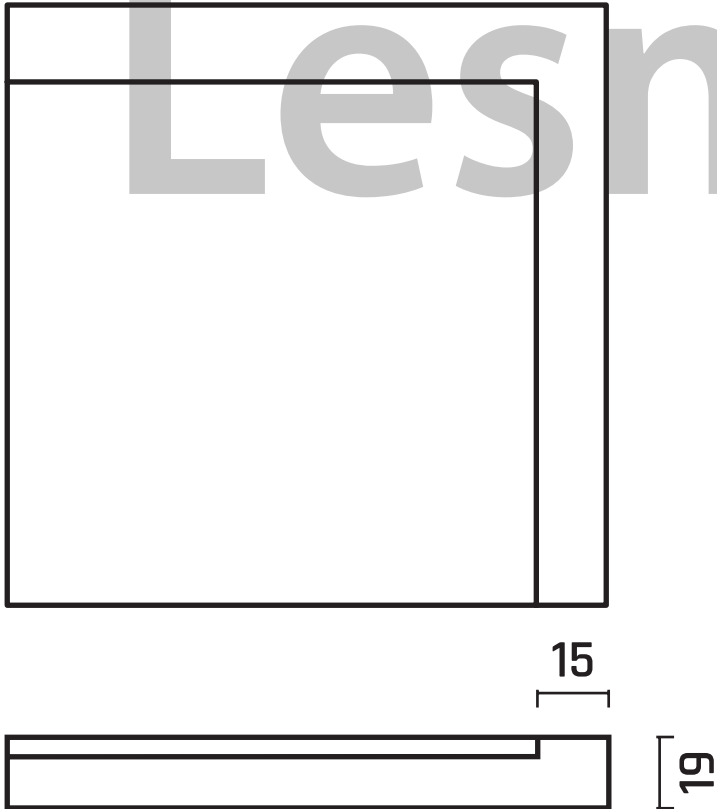
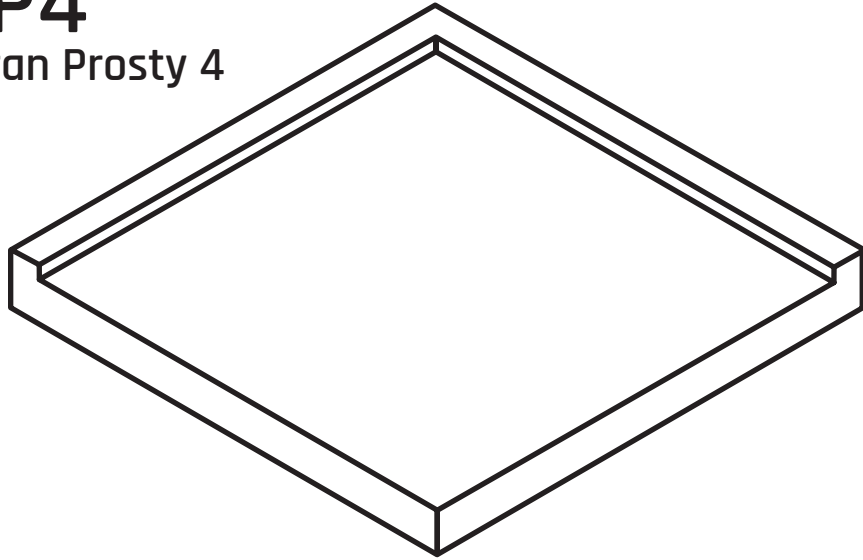

Front

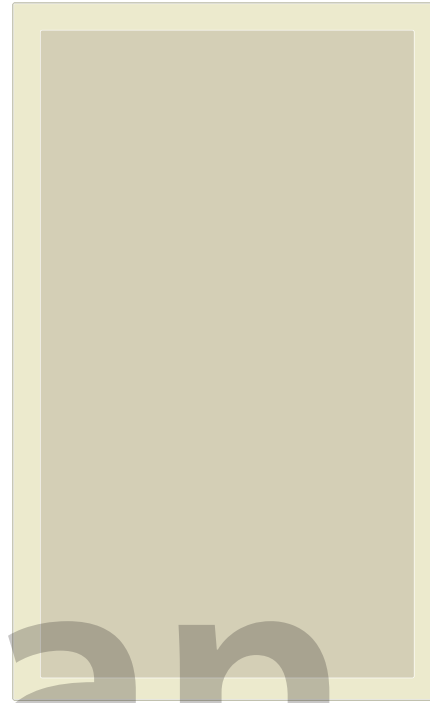

Szuflady

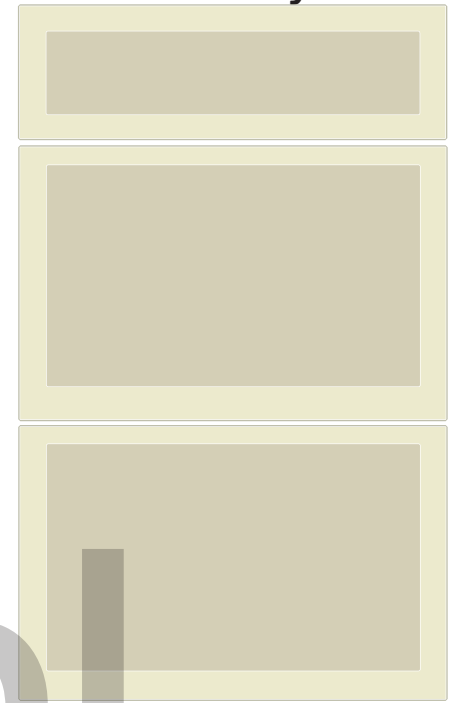

Witryna Szpros

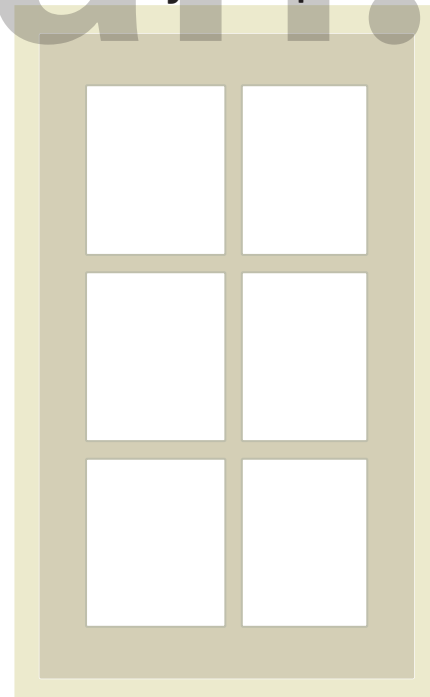

Witryna

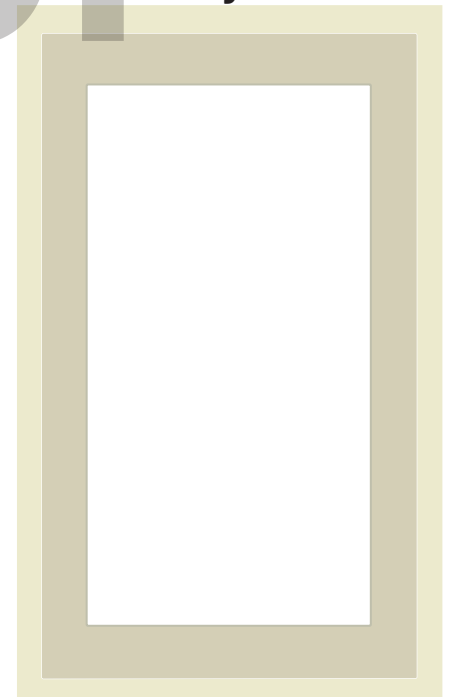

KR1
Kaseton
Ramiak 1

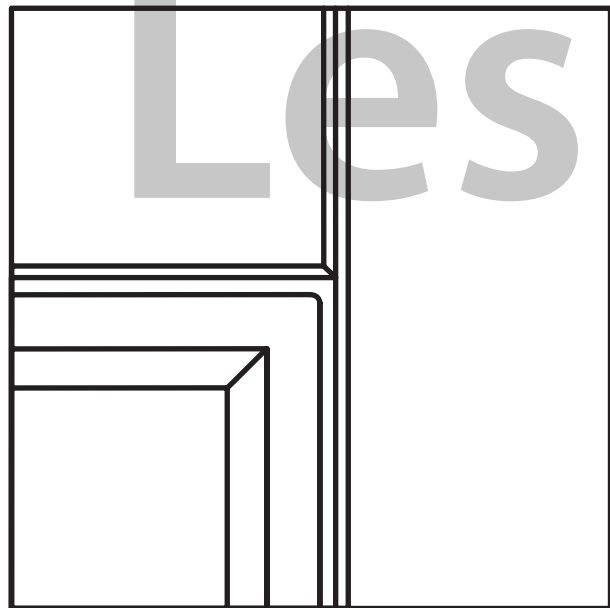
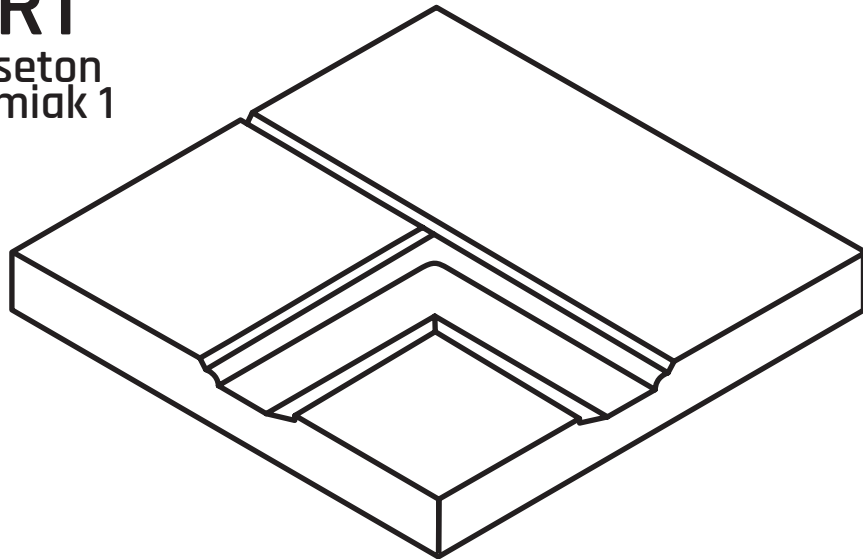

65



19

Front

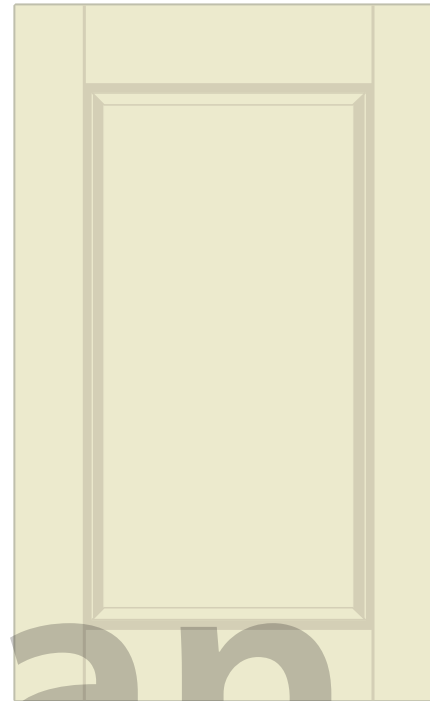

Witryna Szpros

Szuflady

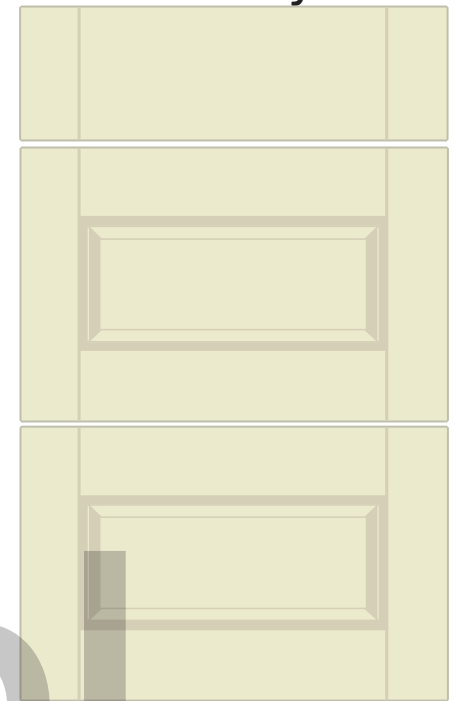

Witryna

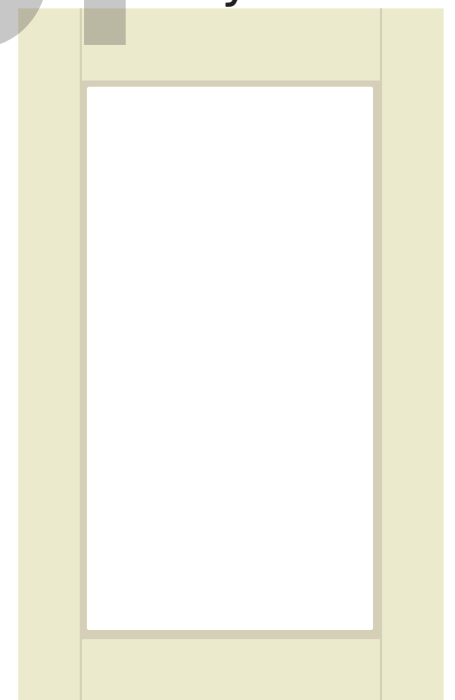
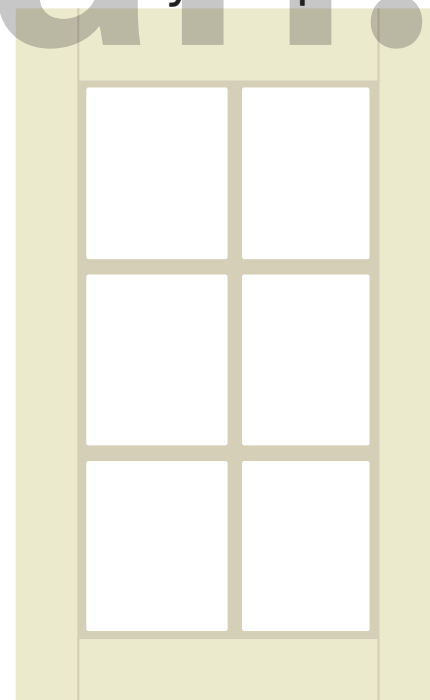

KR2
Kaseton
Ramiak 2

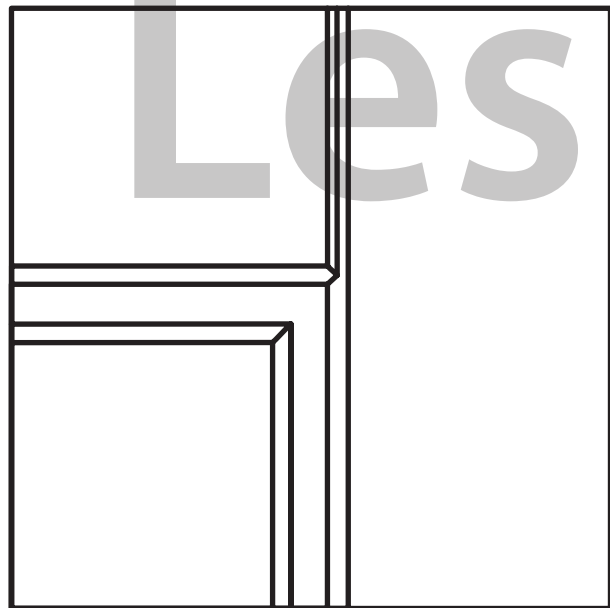
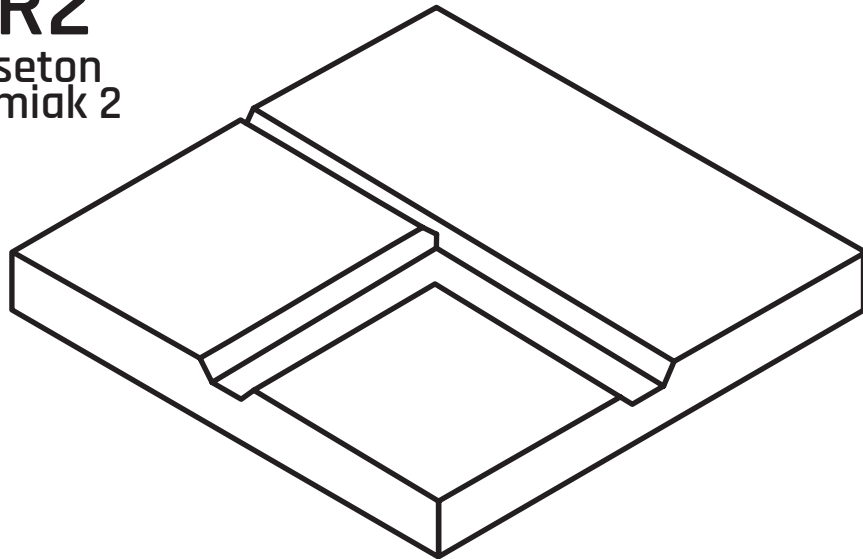

65



19

Front

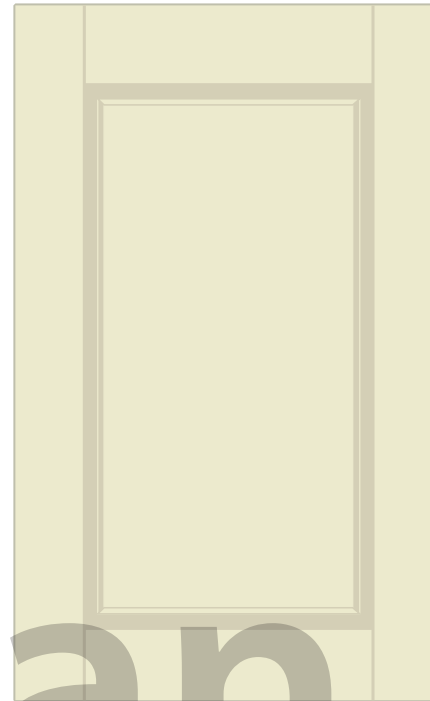

Witryna Szpros

Szuflady

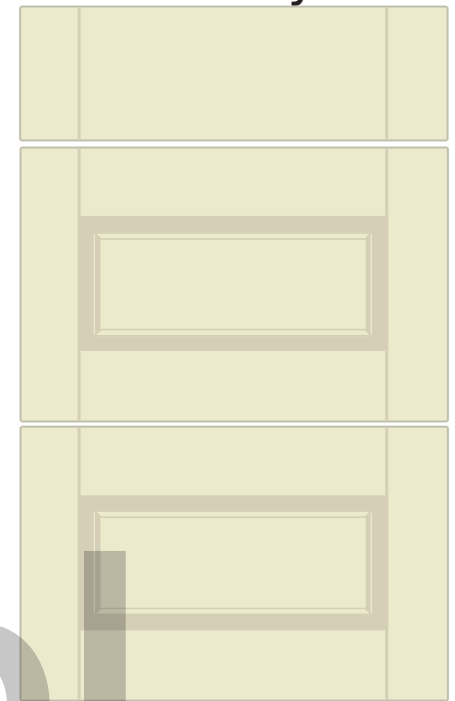

Witryna

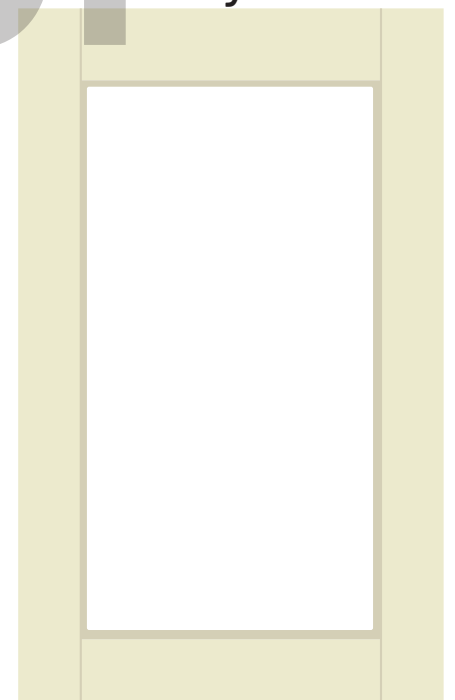
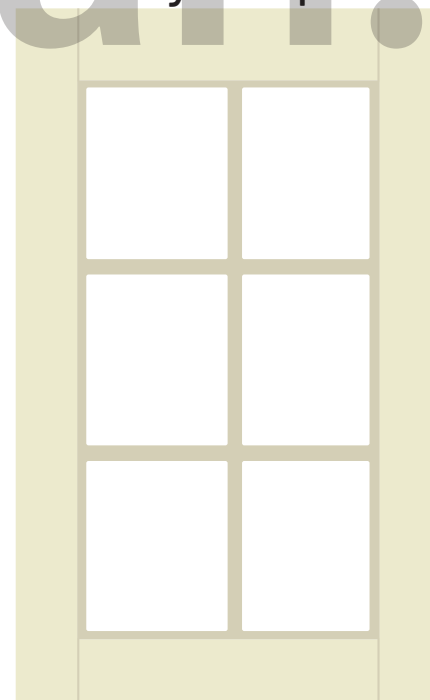

KR3

Kaseton
Ramiak 3

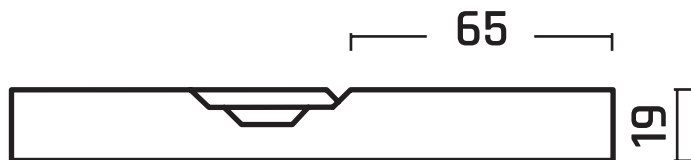
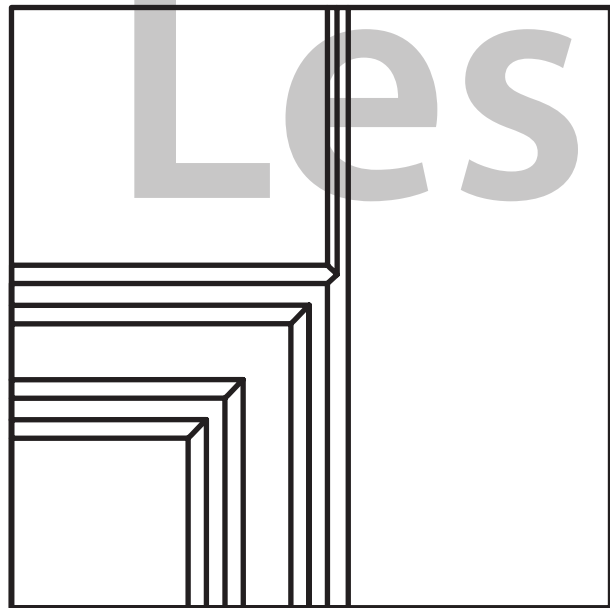
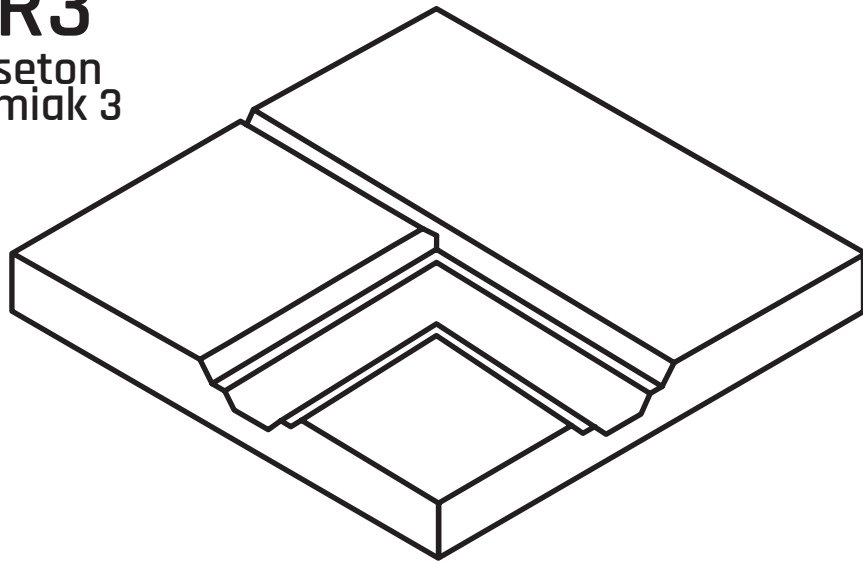

Front

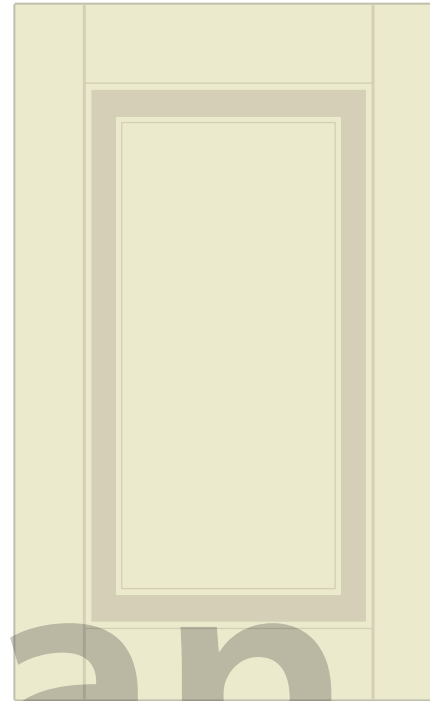

Witryna Szpros

Szuflady

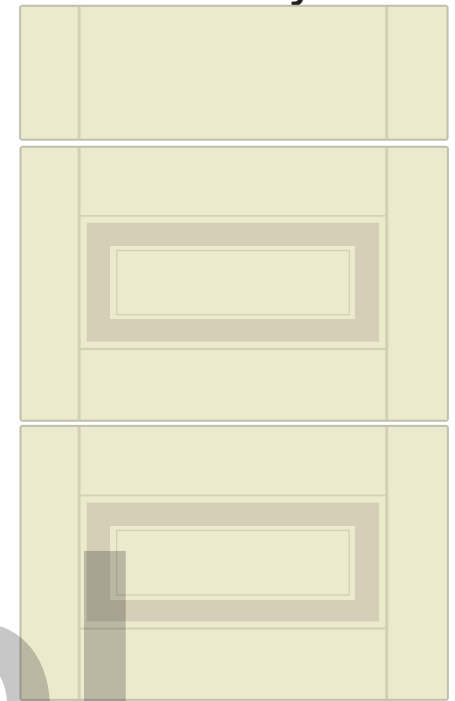

Witryna

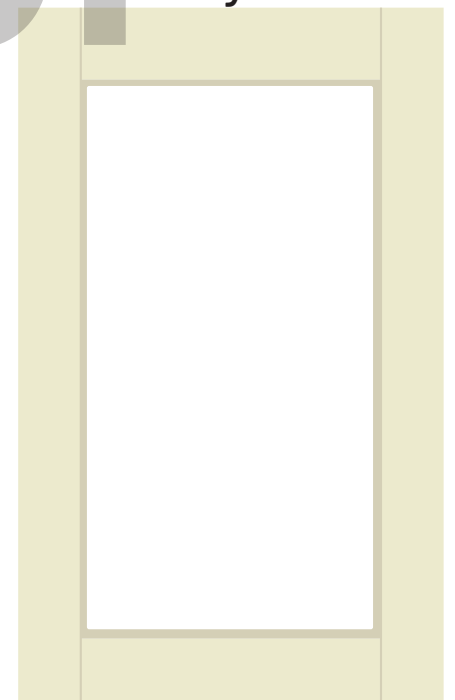
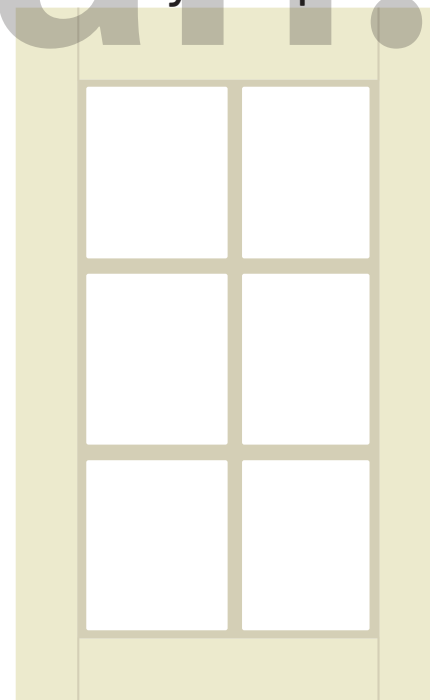

KR4
Kaseton
Ramiak 4

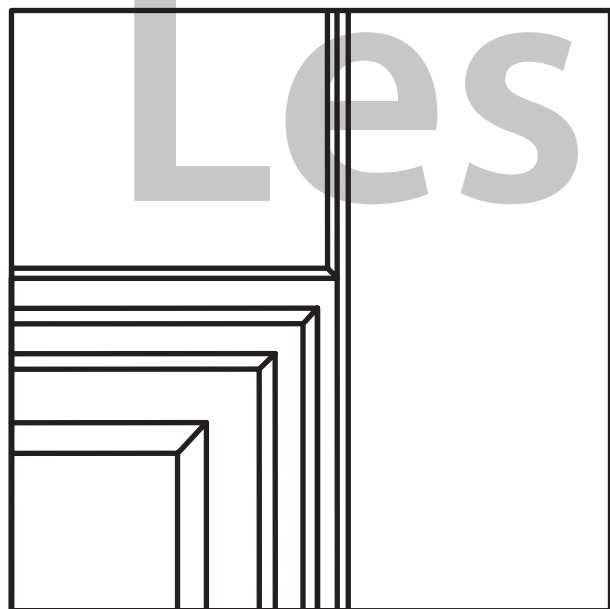
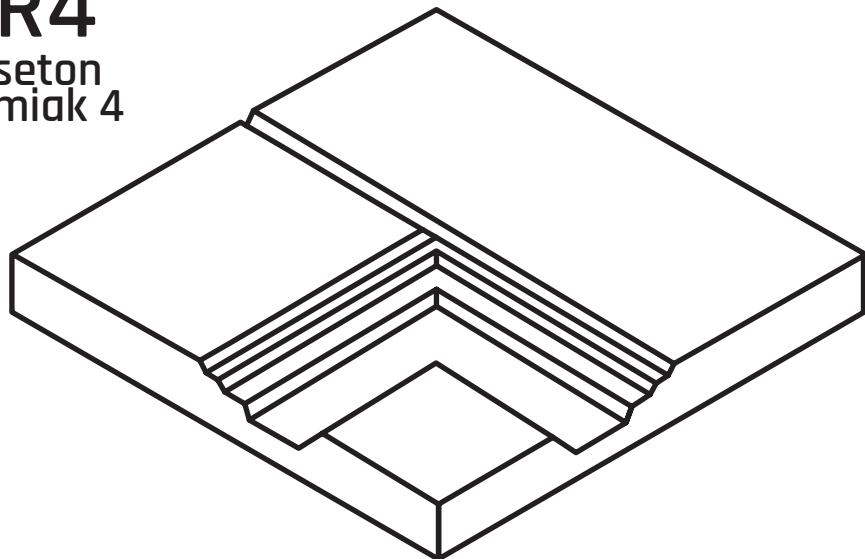

Front

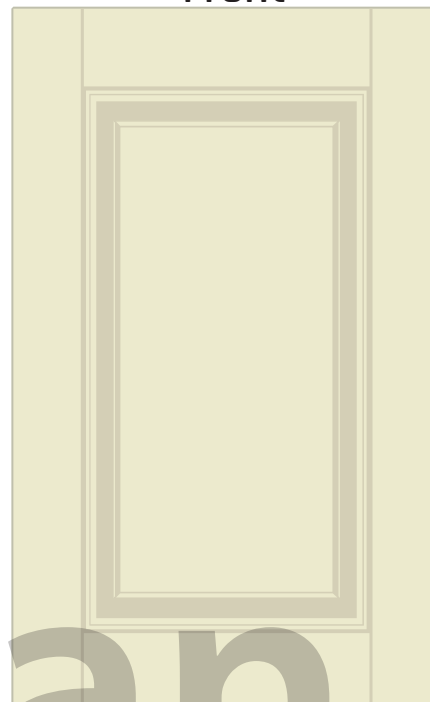

Witryna Szpros

Szuflady

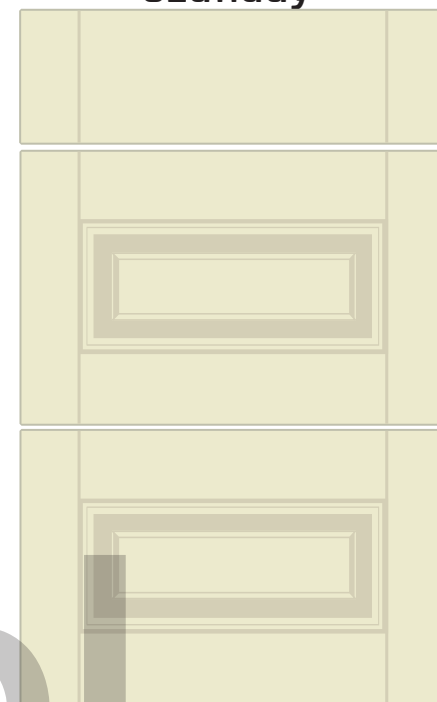

Witryna

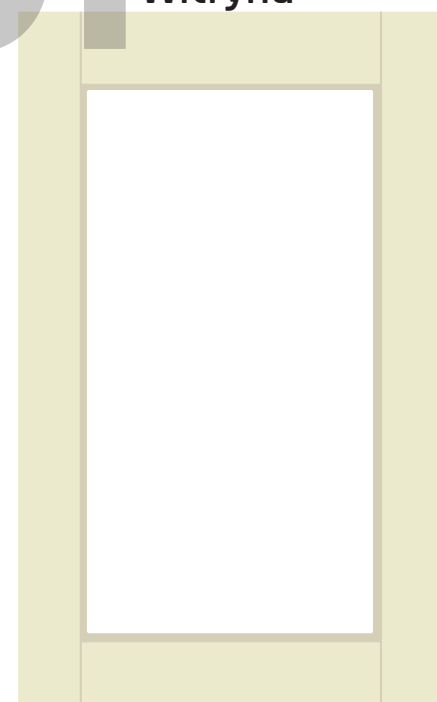
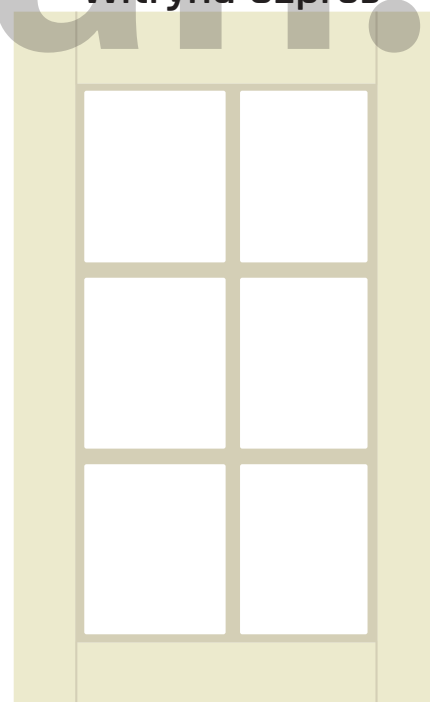

K1
Kaseton 1

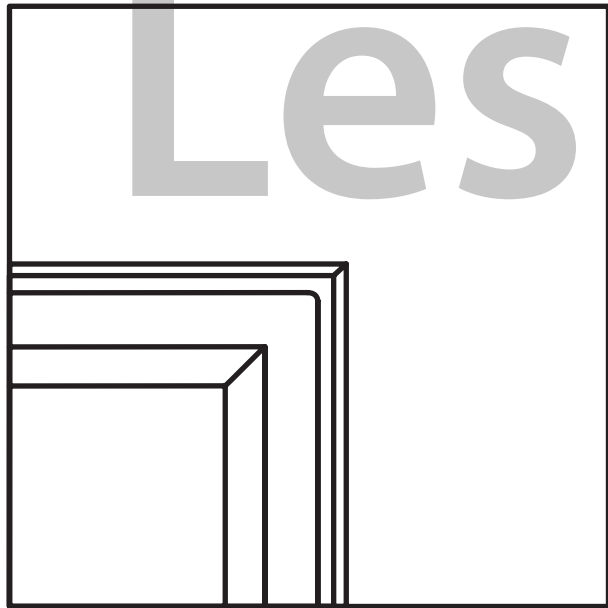
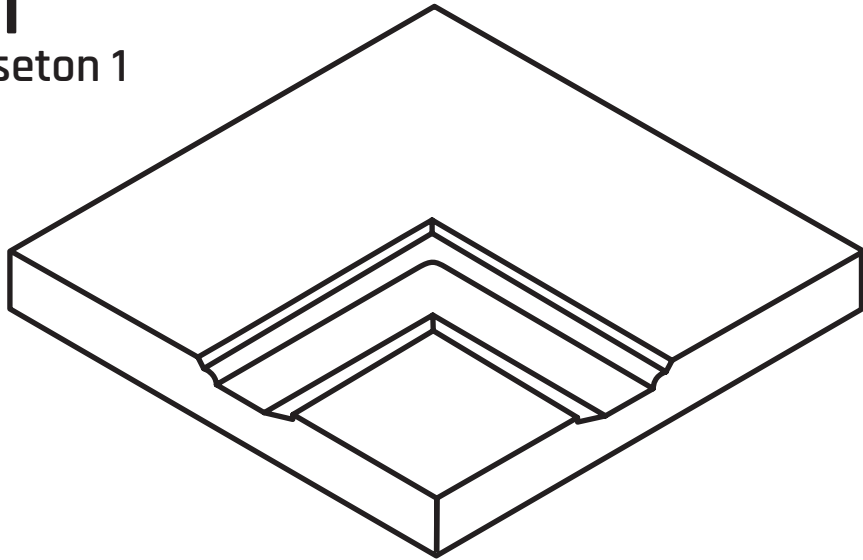

65



19

Front

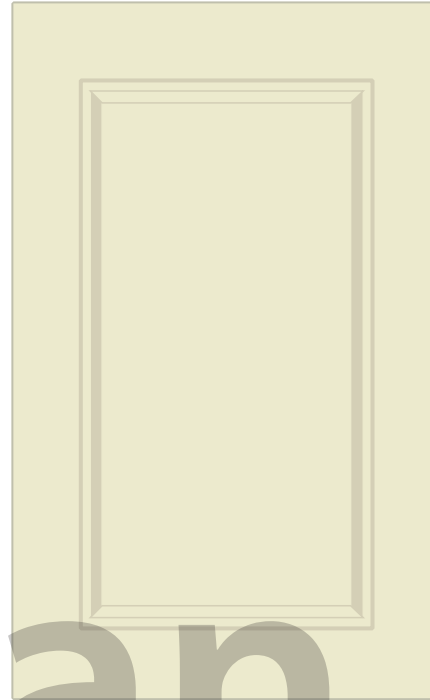

Witryna Szpros

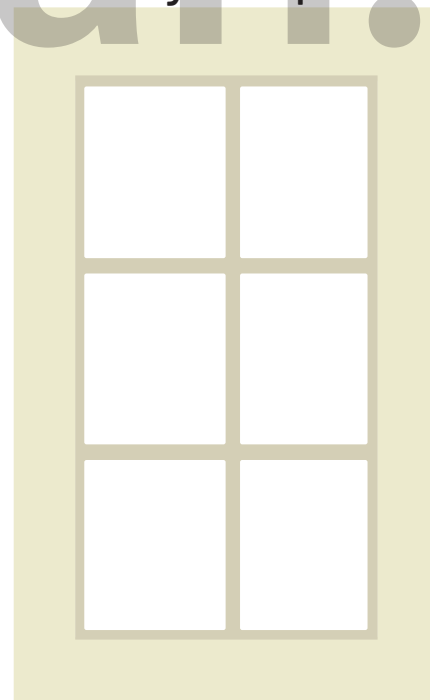

Szuflady

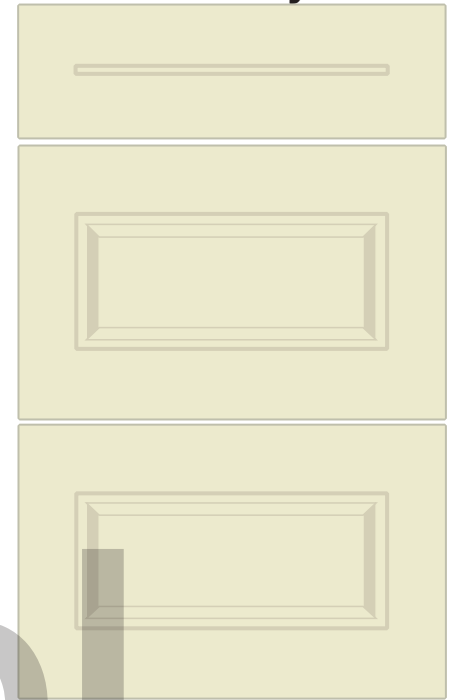

Witryna

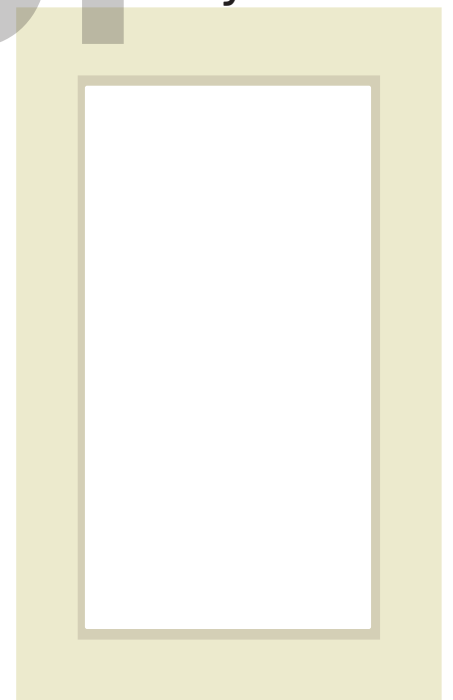

K2
Kaseton 2

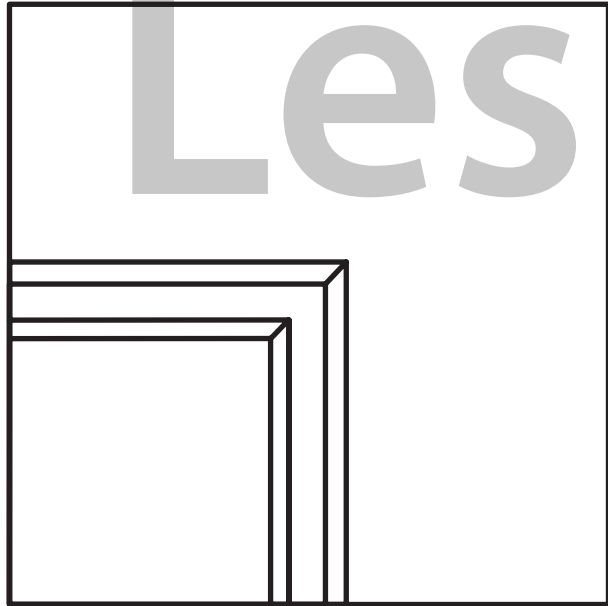
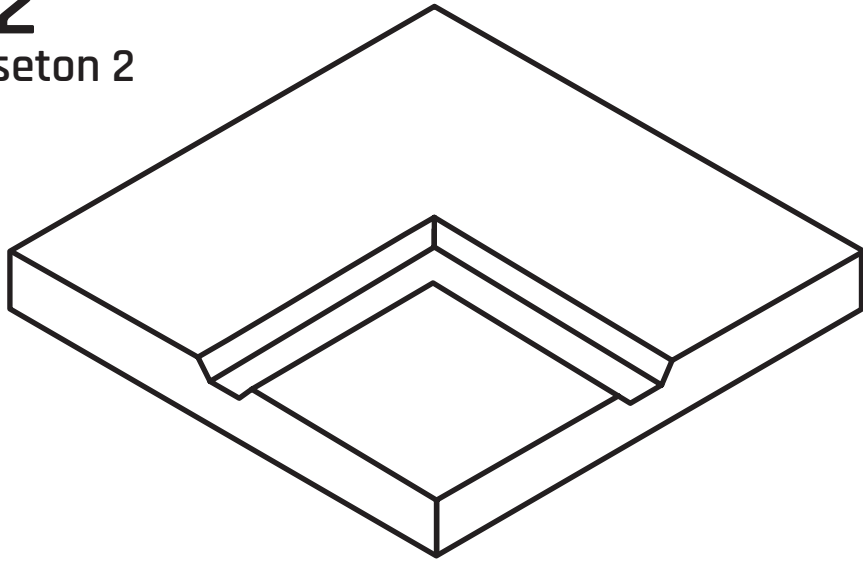

65



19

Front

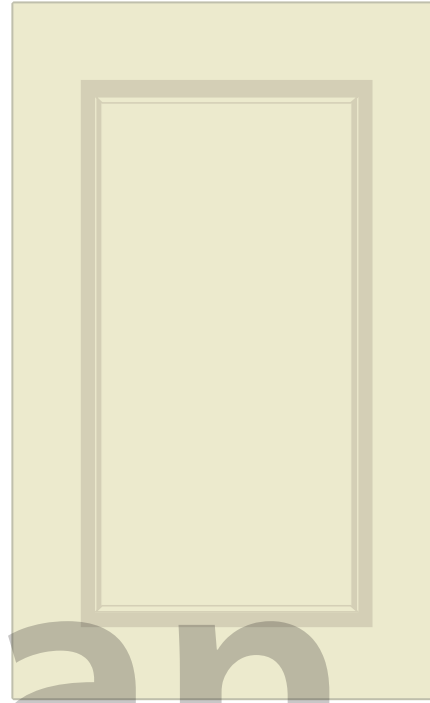

Witryna Szpros

Szuflady

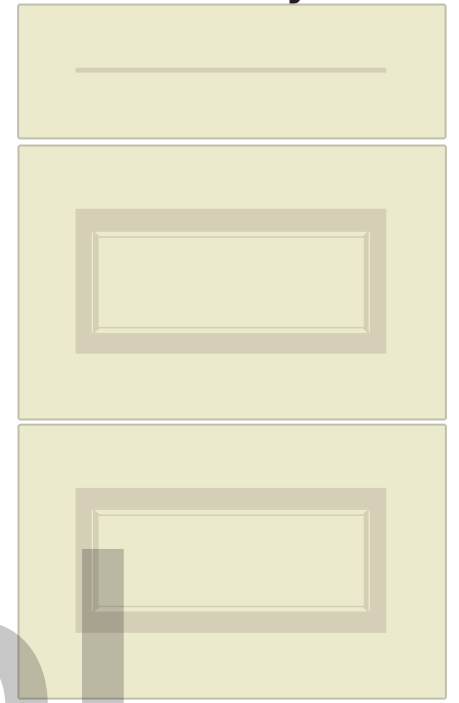

Witryna

K3

Kaseton 3

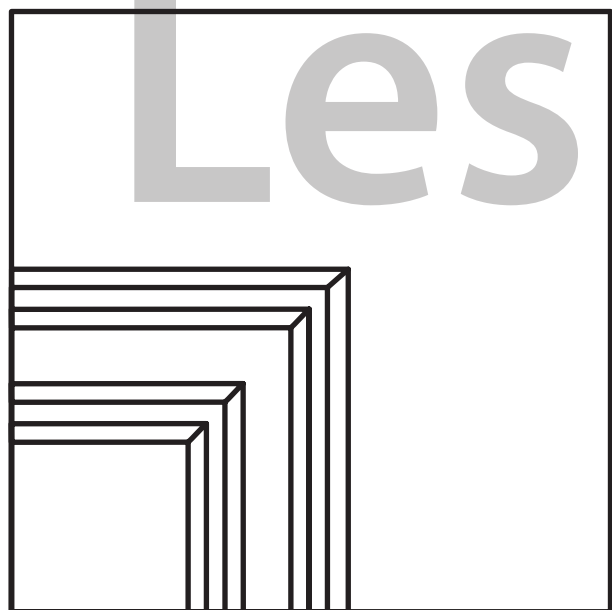
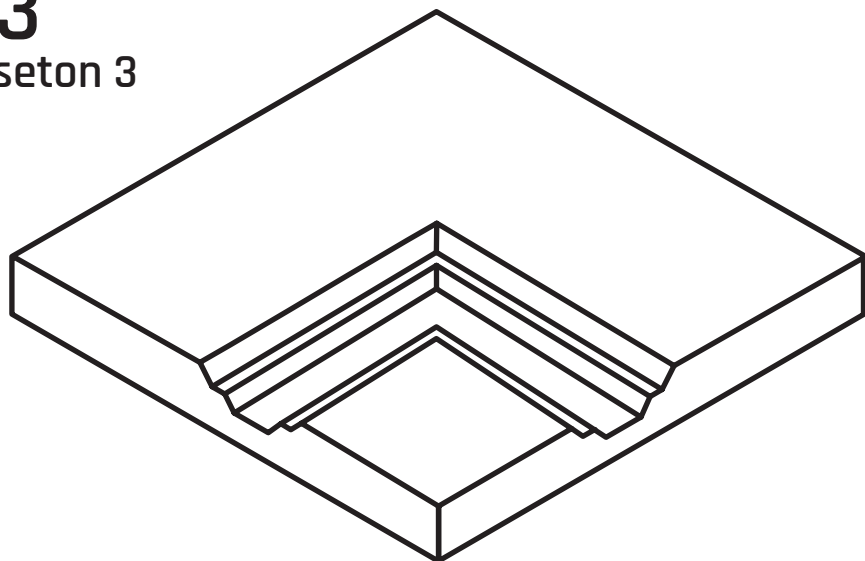

65



19

Front

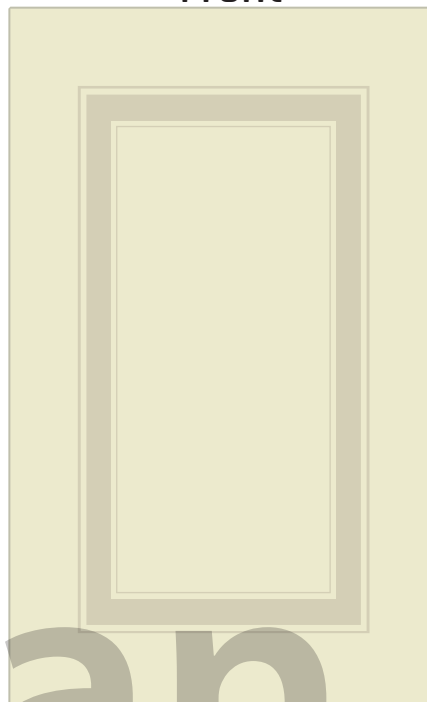

Witryna Szpros

Szuflady

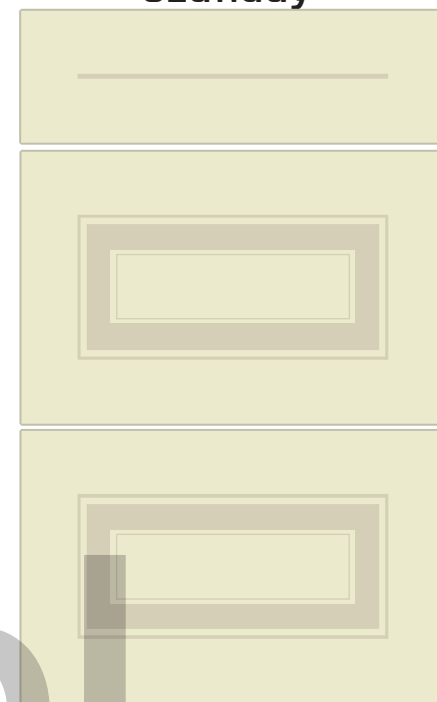

Witryna

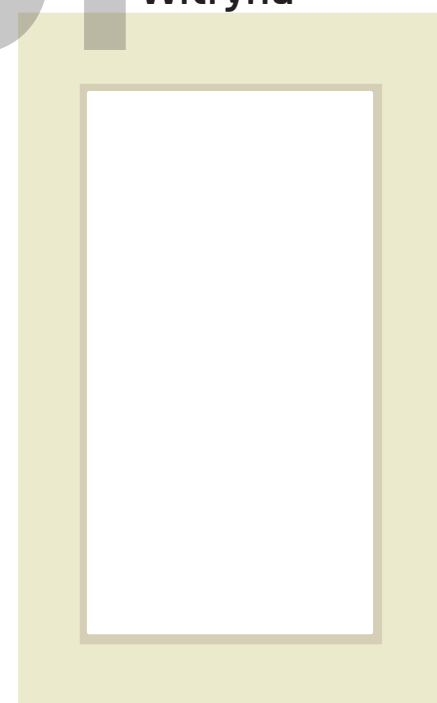
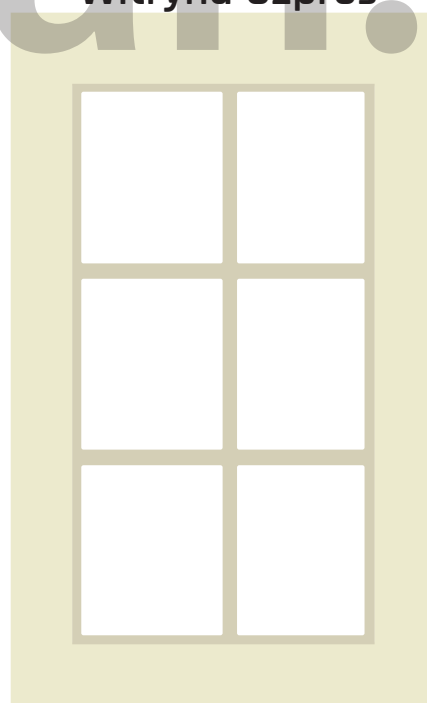

K4

Kaseton 4

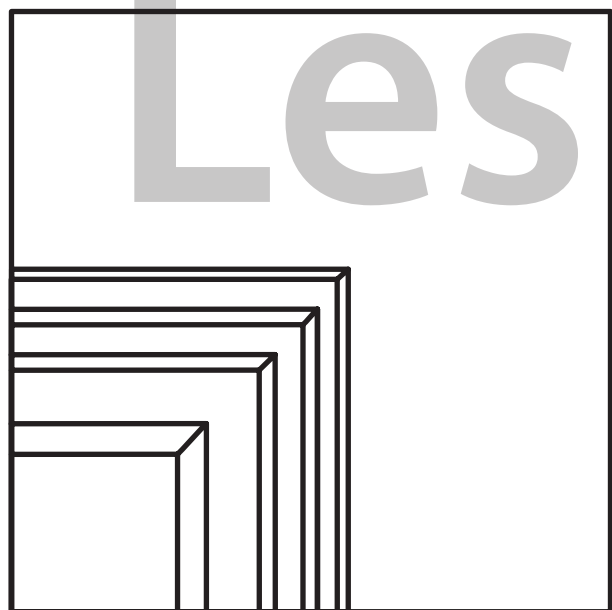
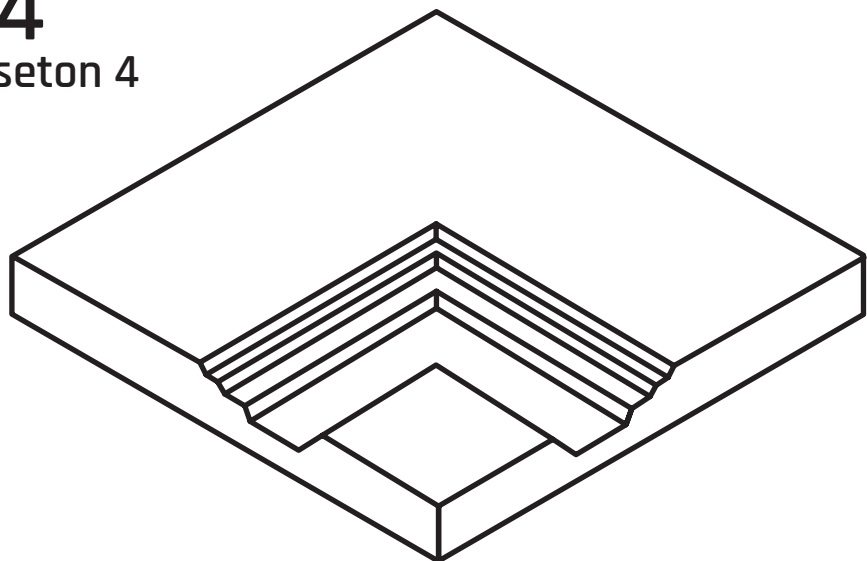

65



19

Front

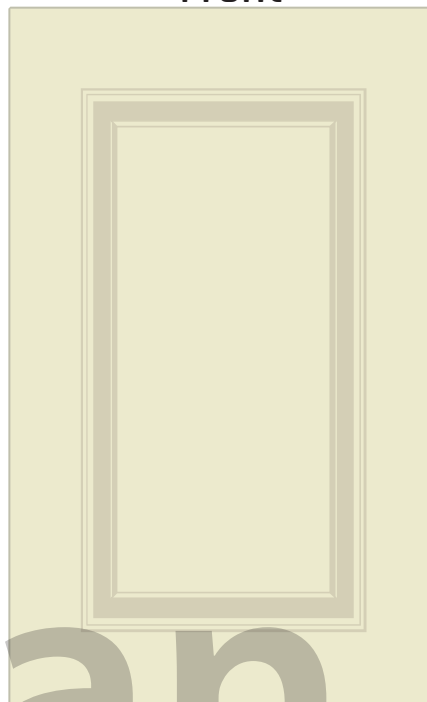

Witryna Szpros

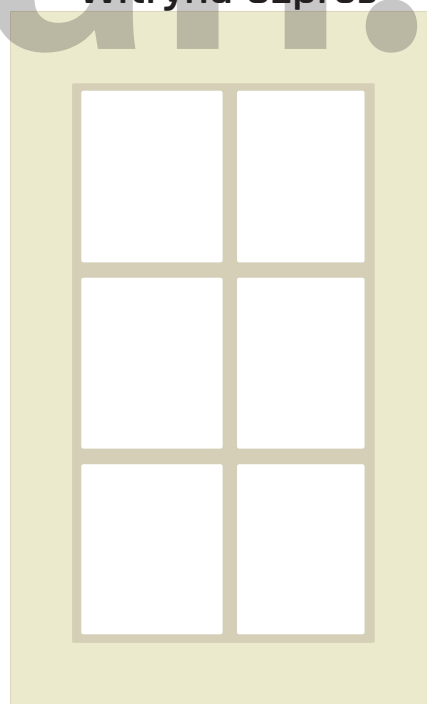

Szuflady

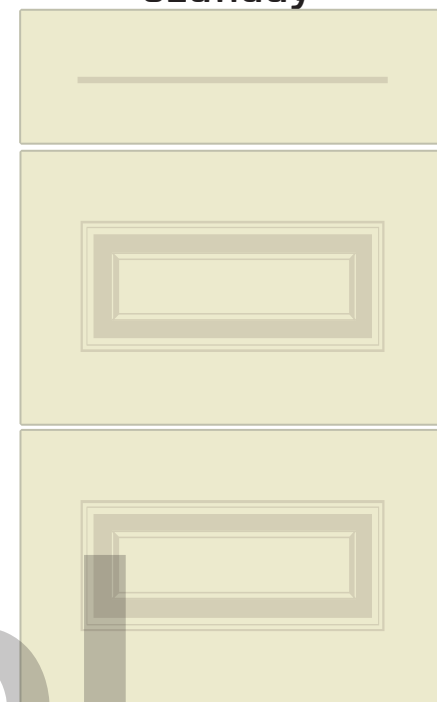

Witryna

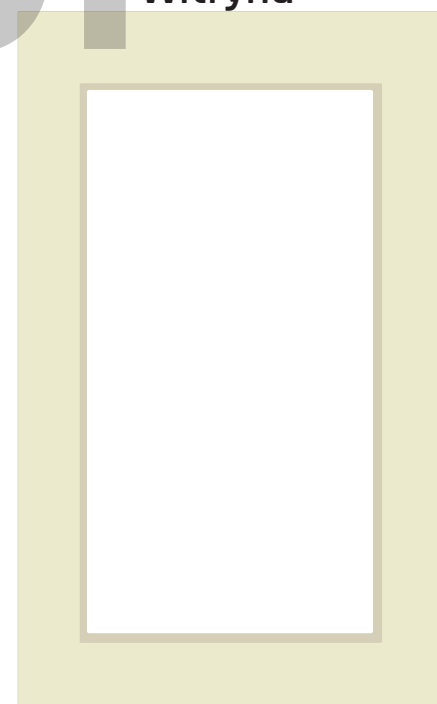

B

Blenda/Pilaster



50-70

B1



50-70

B2



50-70

B1



50-70

B1

W

Półka na wino



140-220



221-350

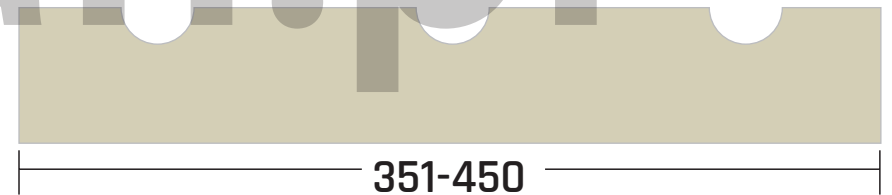

351-450

lesman.pl